

# MERLYN™

THE COLLECTION





At MERLYN, our goal is to make a positive impact on the planet by taking various actions that are environmentally friendly. Planet Mark, a well-known sustainability certification body, has verified that we have calculated, lowered, and offset for our carbon footprint. We continue to work towards our goal with ongoing initiatives such as the electrification of our company vehicle fleet.

In line with our commitment to reduction in annual carbon footprint of 5% we have taken steps by collaborating with our offset partner, Ecologi.

In doing so, we are delighted to support a wind farm in Sri Lanka, a venture that aligns with our goal to drive environmental improvements and create a better planet.

Please be aware our cover is non recyclable. Remove cover before recycling the internal pages.



INFORMATION  
ON ECOLOGI



RECYCLABLE  
BROCHURE



PlanetMark

MERLYN™  
THE COLLECTION



**NEW**

# MERLYN™ | Spare Parts

**LOOKING FOR RELIABLE, AUTHENTIC  
MERLYN SPARE PARTS FOR YOUR SHOWER?**

Our online store offers a wide range of stock,  
ready for shipping.

[www.merlynshowering.com](http://www.merlynshowering.com)



SCAN FOR MORE  
INFORMATION



# Contents

## *about*

The Collection .....	4
Welcome to MERLYN .....	6
MERLYN Customer Service .....	7

## *collections*

### MERLYN SERIES:

10 Series .....	9
8 Series Frameless .....	17
8 Series .....	29
6 Series .....	37

### MERLYN IONIC:

Ionic Essence Frameless .....	45
Ionic Essence Framed .....	61
Ionic Express .....	69
Ionic Source .....	79

### MERLYN IQ .....

### The MERLYN Wetroom Collection .....

### Bath Screens .....

### MERLYN Trays:.....

TrueStone Trays .....	139
Level25 & Level25-SR Trays .....	141
Touchstone & Touchstone-SR Trays ...	145
Mstone.....	149
Upstand.....	151

## *technical information*

Product Information .....	152
---------------------------	-----



# MERLYN series

Style & Functionality



Exquisite product range. Balance of beauty and movement giving the user a sense of pure luxury and lifetime guarantee.

<b>10 Series</b>	Height: 2100mm	Glass: 10mm
<b>8 Series Frameless</b>	Height: 1950mm	Glass: 8mm
<b>8 Series</b>	Height: 1950mm	Glass: 8mm
<b>6 Series</b>	Height: 1900mm	Glass: 6mm

*A select few of our doors are available in different heights.*

# MERLYN IONIC

Easy Fit



Features high-quality materials and finishes, ensuring durability and longevity with lifetime guarantee.

<b>Ionic Essence Framed</b>	Height: 1900mm	Glass: 8mm
<b>Ionic Essence Frameless</b>	Height: 2000mm	Glass: 8mm
<b>Ionic Express</b>	Height: 1900mm	Glass: 6mm
<b>Ionic Source (5year)</b>	Height: 1850mm	Glass: 6mm



# MERLYN™

## THE COLLECTION

### It's all about the experience

Made up of shower enclosures, trays, wetrooms and bath screens, the MERLYN Supreme Collection is all about providing the ultimate showering experience – from the smooth running of the shower doors to the beautiful and elegant design and the quality of fittings.

MERLYN



*The easiest door you will ever fit!*



One person install, uses no screws on the frame assembly and is built on the tray, with 10 year guarantee.

**MERLYN IQ**

Height: 1900mm

Glass: 6mm

## MERLYN™ Wetrooms

*Stylish*



Transform your bathroom into a modern and minimalist sanctuary with our wetroom solutions

**10 Series**

Height: 2000mm

Glass: 10mm

**8 Series**

Height: 2015mm

Glass: 8mm

**8mm Wetroom**

Height: 2015mm

Glass: 8mm

*A select few of our doors are available in 1950mm height.*

# MERLYN™

it's all about the experience

Introducing The Collection Brochure, thoughtfully curated to showcase the very best of MERLYN's versatile product range under one cover.

At MERLYN, our commitment to innovation, quality and design permeates throughout this product offering.

This unique approach has helped us to become the leading brand for shower enclosures in the UK and Ireland.

When you choose a MERLYN shower, now conveniently portrayed in this New Collection Brochure, you are investing in one of the most trusted shower brands, backed up by the MERLYN Guarantee giving you total peace of mind.

Thank you for choosing MERLYN.

Sincerely,

The MERLYN Team



Follow us online @merlynshowering to keep up to-date.











## *Award-Winning Customer Service*

It is not about what we do but what we can do for you. We promise we will always be there for you at any stage of your journey with MERLYN. We have a genuine commitment to service and to finding a solution for you. Our specialised team's philosophy is to make everything easy for you and we will respond immediately to any request you might have.

We strive everyday to make excellence a habit. Contact our award winning dedicated team of specialists, who are on hand to give you a personalised solution to your query.

 T: 0808 101 1429  WhatsApp: +353 8601 00 002  E: [sales@merlyn.ie](mailto:sales@merlyn.ie)

-  Download our brochures
-  Find your nearest stockist
-  Download our easy-to-use fitting instructions and technical information
-  Register your Guarantee

**Check out our website: [merlynshowering.com](http://merlynshowering.com)**







# 10 | series

## Exquisite design

This range is the flagship of the MERLYN Series collection, showcasing the very finest in style and quality. These elegantly crafted solid doors allow you to add your own personal touch. An excellent choice for those looking for a statement piece in the bathroom.



*Quiet glide wheels*



*A choice of handles to suit your own personal style*



*Stunningly crafted transparent glass*



10 Series Sliding Door in Recess / Shown as Right Hand (R)

### Technical drawing

#### Sliding Door in Recess



Size	X Min-Max	A	B
1000	405-300	470	510
1100	455-350	520	560
1200	505-400	570	610
1400	605-500	670	710
1500	605-500	670	810
1600	605-500	670	910
1700	605-500	670	1010

- A: Moving Panel
- B: Fixed Panel
- D: Side Panel
- X: Door Opening

Opening size can be adjusted to your requirements

A total of 35mm adjustment (max of 12mm adjustment in wall profile on closing side for out of true walls i.e. on right hand side of image shown). Extension profiles available. See page 153.

#### Sliding Door with Side Panel

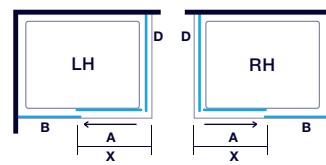

Size	D
760	665
800	705
900	805



## Sliding Door

Our sliding door in recess is a definite style statement. While minimalist in appearance it has an impressive 10mm toughened glass, making it the flagship of the MERLYN Series Collection range.

### features

- » Height 2100mm
- » Eyelet handle with chrome eyelet option and circular filler plate option
- » Extra smooth roller action for quiet closing
- » Door handed - order Left Hand (L) or Right Hand (R)
- » Wetroom compatible

#### Sliding Door in Recess

Size	Tray Finish Adjustment	Code	Price £ Exc. VAT	Price £ Inc. VAT
1000	950-985	M108231C L or R	2075.83	2491.00
1100	1050-1085	M108251C L or R	2075.83	2491.00
1200	1150-1185	M108241C L or R	2075.83	2491.00
1400	1350-1385	M108291C L or R	2165.83	2599.00
1500	1450-1485	M108281C L or R	2360.00	2832.00
1600	1550-1585	M108271C L or R	2406.67	2888.00
1700	1650-1685	M1081700CH L or R	2455.00	2946.00

This product is handed please choose L for left and R for right when ordering.  
Please add 15mm to tray finish adjustment when using a Side Panel.

#### Optional Side Panel

Size	Tray Finish Adjustment	Order Code	Price £ Exc. VAT	Price £ Inc. VAT
760	730-750	M102210C	987.50	1185.00
800	770-790	M102211C	987.50	1185.00
900	870-890	M102221C	978.33	1174.00

Please Note: Moving panel door must close onto the side panel.  
For wetroom installation, please reduce tray finish adjustment by 20mm.



SCAN FOR MORE  
INFORMATION



Sliding Door with Side Panel / Shown as Right Hand (R)





1 Door Offset Quadrant / Shown as Right Hand (R)

Technical drawing

1 Door Offset Quadrant



Size	X Min-Max	A	B	C
1000 x 800	435-340	520	535	435
1200 x 800	435-340	520	535	635
1200 x 900	485-390	580	575	635
1400 x 800	435-340	520	535	835

1 Door Quadrant

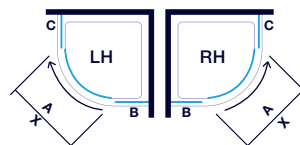

Size	X Min-Max	A	B	C
800	435-340	520	535	235
900	485-390	580	575	340

A: Moving Panel  
B: Straight Panel

C: Curved Panel  
X: Door Opening

All sizes suit 550mm radius tray.  
Note: Curved Panels 8mm glass. Extension profiles available. See page 153.

## 1 Door Quadrant

Beautifully curved glass combined with an exceptionally smooth roller action makes this quadrant door the best in its class. Constructed from up to 10mm toughened glass this stunning enclosure offers strength and practicality which belies its beauty.

### features

- » Height 2000mm
- » Up to 10mm toughened glass
- » Eyelet handle with chrome eyelet option and circular filler plate option
- » Extra smooth roller action for quiet closing
- » Door handed-order Left Hand (L) or Right Hand (R)
- » Wetroom compatible

#### 1 Door Quadrant

Size	Tray Finish Adjustment	Code	Price £ Exc. VAT	Price £ Inc. VAT
800 x 800	775-795	M103211C <b>L or R</b>	2563.33	3076.00
900 x 900	875-895	M103221C <b>L or R</b>	2516.67	3020.00

#### 1 Door Offset Quadrant

1000 x 800	975-995 / 775-795	M103233C <b>L or R</b>	2605.83	3127.00
1200 x 800	1175-1195 / 775-795	M103243C <b>L or R</b>	2895.83	3475.00
1200 x 900	1175-1195 / 875-895	M103241C <b>L or R</b>	2897.50	3477.00
1400 x 800	1375-1395 / 775-795	M10148H <b>L or R</b>	3097.50	3717.00

This product is handed please choose L for left and R for right when ordering.

#### MERLYN Dedicated Offset Quadrant Tray (1400 x 800)

Size	Tray Finish Adjustment	Code	Price £ Exc. VAT	Price £ Inc. VAT
1400 x 800		S148Q <b>L or R</b>	434.17	521.00

Please Note: The 1400mmx800mm tray is not an MStone Tray, it is a dedicated single skinned tray.



SCAN FOR MORE  
INFORMATION



1 Door Quadrant



## Pivot Door

The 10 Series Pivot Door is bound to impress in any bathroom. Its substantial 10mm toughened glass and solid chrome angular double handle provide a style statement that befits the beauty of this door.

### features

- » Height 2030mm
- » Solid chrome handle
- » Fully concealed fixings
- » Reversible
- » Wetroom compatible



Pivot Door in Recess / Shown as Left Hand (L)



Pivot Door with Side Panel

#### Pivot Door in a recess

Size	Tray Finish Adjustment	Order Code	Price £ Exc. VAT	Price £ Inc. VAT
800	760-790	M101211C	1841.67	2210.00
900	860-890	M101221C	1873.33	2248.00
1000	960-990	M101231C	1969.17	2363.00

Please reduce tray finish adjustment by 10mm when using a Side Panel.

#### Optional Side Panel

Size	Tray Finish Adjustment	Order Code	Price £ Exc. VAT	Price £ Inc. VAT
800	770-790	M10P2211C	924.17	1109.00
900	870-890	M10P2221C	965.83	1159.00
1200	1170-1190	M10P2241C	1185.00	1422.00

Please Note: Moving panel door must close onto the Side Panel.  
For wetroom installation, please reduce tray finish adjustment by 30mm.

### Technical drawing

Pivot Door in Recess

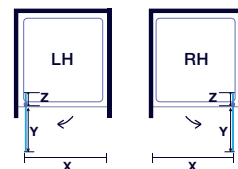

Pivot Door with Side Panel

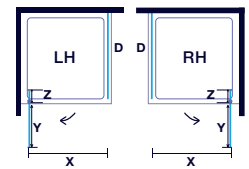

D: Side Panel  
Y: Outside Door Swing  
Z: Inside Door Swing  
X: Door Opening

Size	X Min-Max	Y	Z
800	560	580	135
900	660	680	135
1000	760	780	135

Note: 10mm adjustment only on closing side.  
Extension profiles available.  
See page 153.

## Pivot Door & Inline Panel

The 10 Series Pivot Door & Inline Panel is a luxurious showering choice with solid chrome double handle and 10mm toughened safety glass. Flexible size options available from 1200mm to 1800mm.

### features

- » Height 2030mm
- » Solid chrome handle
- » Fully concealed fixings
- » Reversible
- » Wetroom compatible



Pivot Door & Inline Panel / Shown as Left Handed



Pivot Door & Inline Panel in Recess

### Pivot Door and Inline Panel

Size	Tray Finish Adjustment	Size of Pivot Door Supplied	Size of Pivot Inline Panel Supplied	Code	Price £ Exc. VAT	Price £ Inc. VAT
1200	1150-1190	800	400	M101241C	2445.00	2934.00
1400	1350-1390	800	600	M101291C	2565.00	3078.00
1500	1450-1490	900	600	M101261C	2578.33	3094.00
1600	1550-1590	800	800	M101271C	2708.33	3250.00
1700	1650-1690	900	800	M101281C	2722.50	3267.00
1800	1750-1790	1000	800	M101218C	2814.17	3377.00

### Optional Pivot Door and Inline Panel Side Panel

Size	Tray Finish Adjustment	Code	Price £ Exc. VAT	Price £ Inc. VAT
800	770-790	M10PIL2211C	825.00	990.00
900	870-890	M10PIL2221C	942.50	1131.00

For wetroom installation, please reduce tray finish adjustment by 10mm.  
Please Note: Moving panel door must close onto the Inline Panel.

### Technical drawing

Pivot Door & Inline Panel in Recess

Pivot Door & Inline Panel with Side Panel



C: Fixed Panel  
D: Side Panel  
Y: Outside Door Swing  
X: Door Opening

Extension profiles available.  
See page 153.

Size	X Min-Max	Y	C
1200	560	580	410
1400	560	580	610
1500	660	680	610
1600	560	580	810
1700	660	680	810
1800	760	780	810





8<sup>MM</sup>  
GLASS  
THICKNESS

LIFETIME  
GUARANTEE

MERSHIELD™  
STAYCLEAR

# 8 | series | *frameless*

8 | series | *frameless*

A minimalist, designer frame.

This range has a minimalist frame design, one of the most popular trends in shower enclosures. The frameless design gives a refined look, while enhancing the sense of space and light in your bathroom. The frameless design is easy to clean and maintain.



*Crafted transparent glass*



*Ultra slim hinges for added style*



*Our exclusive horizontal handle which offers the perfect symmetry and solid feel to this truly stunning range.*

SHOWER ENCLOSURES



*Sliding Door with Side Panel / Shown as Right Hand (R)*

*Technical drawing*

Sliding Door in Recess

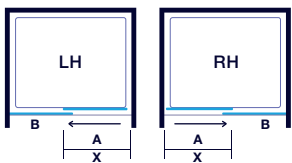

Sliding Door with Side Panel

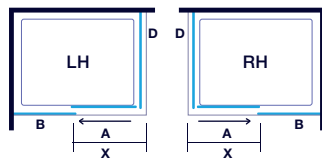

- A: Moving Panel
- B: Fixed Panel
- D: Side Panel
- X: Door Opening

Size	X	A	B	D
1200	450	605	565	710
1400	550	705	665	810



## Sliding Door

The 8 Series Frameless Sliding Door has the smoothest rolling action that needs to be seen to be believed. With its sleek minimalist frame and stunning designer features; it will bring a touch of class to any bathroom.

### features

- » Height 2000mm
- » Concealed fixings
- » Mershiield Stayclear™ easy clean protected glass
- » Translucent seals
- » Reversible
- » Wetroom compatible
- » Lifetime Guarantee

#### Sliding Door

Size	Tray Finish Adjustment	Code	Price £ Exc. VAT	Price £ Inc. VAT
1200	1150-1190	A0920DH	1366.67	1640.00
1400	1350-1390	A0920HH	1574.17	1889.00

Please add 20mm to tray finish adjustment when using a Side Panel.

#### Optional Side Panel

Size	Tray Finish Adjustment	Code	Price £ Exc. VAT	Price £ Inc. VAT
800	765-790	A0920LH	715.00	858.00
900	865-890	A0920PH	758.33	910.00

For wetroom installation, please reduce tray finish adjustment by 20mm.

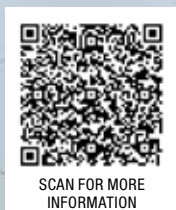

SCAN FOR MORE INFORMATION





*Hinged Bifold Door in Recess / Shown as Right Hand (R)*

*Technical drawing*

Hinged Bifold Door in Recess

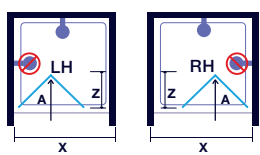

Hinged Bifold Door with Side Panel

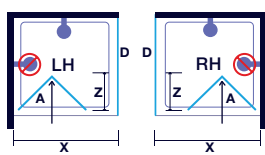

Size	X	Z	A
760	520	355	309/309
800	560	375	329/329
900	670	425	379/379
1000	780	475	429/429

X: Door Opening

Z: Width of panel when folded

Extension profiles available. See page 153.



## Hinged Bifold Door

The 8 Series Frameless Bifold is an ingenious space saving solution for bathrooms with space restrictions, the hero of the bijou bathroom. Folding away neatly and horizontally flush to the wall, this screen allows you to double your feeling of space in any small bathroom giving you that extra elbow room you desire.

### features

- » Height 1950mm
- » Frameless
- » Minimal designer hinges
- » Space solution
- » Reversible

#### Hinged Bifold Door

Size	Tray Finish Adjustment	Code	Price £ Exc. VAT	Price £ Inc. VAT
760	720-750	M87111	1051.67	1262.00
800	760-790	M87211	1087.50	1305.00
900	860-890	M87221	1147.50	1377.00
1000	960-990	M87231	1185.83	1423.00

Please reduce tray finish adjustment by 5mm when using a Side Panel.

#### Optional Side Panel

Size	Tray Finish Adjustment	Code	Price £ Exc. VAT	Price £ Inc. VAT
760	715-735	M82101	713.33	856.00
800	755-775	M82102	713.33	856.00
900	855-875	M82103	755.83	907.00

For wetroom installation, reduce tray finish adjustment by 5mm.  
Please note: Moving panel door must close onto the Side Panel.

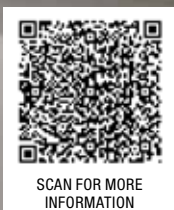

SCAN FOR MORE INFORMATION



Hinged Bifold Door with Side Panel



## 1 Door Quadrant

The stylish 8 Series Frameless Offset Quadrant comes in a range of sizes, providing a spacious showering space that would suit any type of bathroom, traditional or contemporary.

### features

- » Height 2000mm
- » Large horizontal designer handle
- » Secure “Clunk” closing
- » Ultra slim hinges
- » Concealed fixings
- » Reversible
- » Wetroom compatible

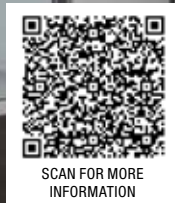

SCAN FOR MORE  
INFORMATION

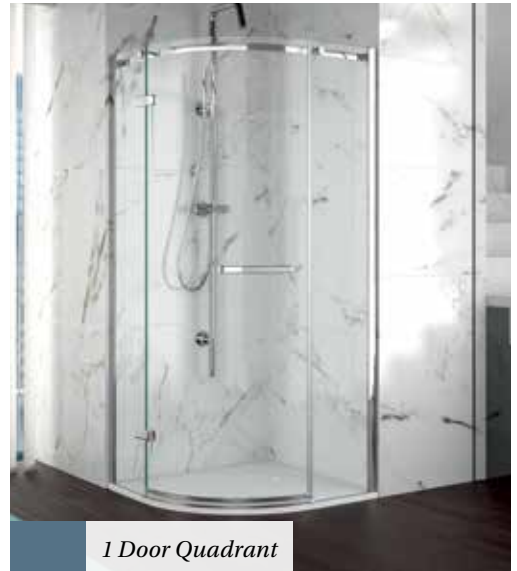

1 Door Offset Quadrant / Shown as Left Hand (L)

1 Door Quadrant

### 1 Door Quadrant

Size	Tray Finish Adjustment	Code	Price £ Exc. VAT	Price £ Inc. VAT
800 x 800	780-800	A0601TH	1840.00	2208.00
900 x 900	880-900	A0601UH	1840.00	2208.00
1000 x 1000	980-1000	A0602ZH	1989.17	2387.00

### 1 Door Offset Quadrant

900 x 760	880-900 / 740-760	A0601CH	2193.33	2632.00
1000 x 800	980-1000 / 780-800	A0601EH	2210.83	2653.00
1200 x 800	1180-1200 / 780-800	A0601HH	2283.33	2740.00
1200 x 900	1180-1200 / 880-900	A0601IH	2283.33	2740.00

### Technical drawing

#### 1 Door Offset Quadrant

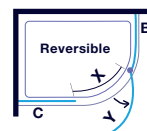

Size	X	Y	B	C
900 x 760	720	790	195	335
1000 x 800	720	790	235	435
1200 x 800	720	790	235	635
1200 x 900	720	790	335	635

#### 1 Door Quadrant

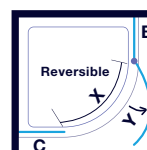

Size	X	Y	B	C
800	720	790	235	235
900	720	790	335	335
1000	720	790	435	435

B: Hinged Fixed Panel  
C: Fixed Panel  
X: Door Opening  
Y: Panel Swing

All sizes to suit a 550mm Radius Tray. Extension profiles available. See page 153.





## Pivot Door

The 8 Series Frameless Pivot Door is practical, stylish and the perfect solution for recess and corner situations. At a height of 1950mm, this enclosure is the perfect choice.

### features

- » Height 1950mm
- » Solid chrome double handle
- » Cover caps
- » Space saving solution
- » Inward and outward opening swing
- » Concealed fixings
- » Reversible
- » Wetroom compatible

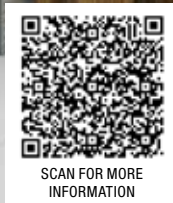

Pivot Door with Side Panel / Shown as Right Hand (R)



Pivot Door in Recess

### Pivot Door in a Recess

Size	Tray Finish Adjustment	Code	Price £ Exc. VAT	Price £ Inc. VAT
760	730-760	S8FPV76	815.83	979.00
800	770-800	S8FPV80	839.17	1007.00
900	870-900	S8FPV90	893.33	1072.00
1000	970-1000	S8FPV100	924.17	1109.00

### Optional Pivot Door Side Panel

Size	Tray Finish Adjustment	Code	Price £ Exc. VAT	Price £ Inc. VAT
760	735-755	S8FSP76PV	685.00	822.00
800	775-795	S8FSP80PV	679.17	815.00
900	875-895	S8FSP90PV	720.00	864.00
1000	975-995	S8FSP100PV	825.00	990.00
1200	1175-1195	S8FSP120PV	943.33	1132.00

For wetroom installation, please reduce tray finish adjustment by 10mm.

### Technical drawing

#### Pivot Door Recess



#### Pivot Door with Side Panel

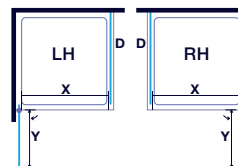

Size	X	Y
760	642	640
800	682	680
900	782	780
1000	882	880

X: Door Opening  
Y: Outside Door Swing

Note: 10mm adjustment only on closing side.  
Extension profiles available. See page 153.



Hinge and Inline Door in Recess / Shown as Right Hand (R)

Technical drawing

Hinge and Inline Door a Recess

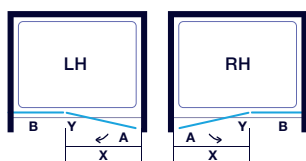

Hinge and Inline Door with Side Panel

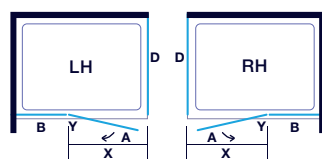

A: Moving Panel  
 B: Fixed Panel  
 D: Side Panel  
 Y: Door Swing  
 X: Door Opening

Size	X	Y	B
900	560	630	240
900+	560	630	285
1000	645	710	260
1000+	690	755	260
1100	645	710	360
1100+	690	755	360
1200	645	710	460

Size	X	Y	B
1200+	690	755	460
1400	645	710	660
1400+	690	755	660
1600	645	710	860
1600+	690	755	860
1700	645	710	960
1700+	690	755	960

Extension profiles available. See page 153.

## Hinge and Inline

A hugely practical yet stylish option, the 8 Series Frameless Hinge & Inline in a Recess is perfect for recesses or en suites. The Hinge and Inline redefines the art of showering with its creative fusion of style and practicality.

### features

- » Height 2000mm
- » Large horizontal designer handle including internal clutch bar handle
- » Secure “Clunk” closing
- » Ultra slim hinges
- » Concealed fixings
- » Reversible
- » Wetroom compatible

#### Hinge and Inline in a Recess

Size	Tray Finish Adjustment	Code	Price £ Exc. VAT	Price £ Inc. VAT
900	860-905	A0611X0	1672.50	2007.00
900+	905-950	A0611Y0	1672.50	2007.00
1000	960-1005	A0611RH	1596.67	1916.00
1000+	1005-1050	A0611RF	1596.67	1916.00
1100	1060-1105	A0611SH	1705.83	2047.00
1100+	1105-1150	A0611SF	1705.83	2047.00
1200	1160-1205	A0611TH	1730.00	2076.00
1200+	1205-1250	A0611TF	1730.00	2076.00
1400	1360-1405	A0611UH	2172.50	2607.00
1400+	1405-1450	A0611UF	2172.50	2607.00
1600	1560-1605	A0611VH	2255.83	2707.00
1600+	1605-1650	A0611VF	2128.33	2554.00
1700	1660-1705	A0611WH	2325.83	2791.00
1700+	1705-1750	A0611WF	2325.83	2791.00

Please Note: + Sizes indicate opening when fitted with side panel

#### Hinge and Inline sizes must be used with Side Panel

Size	Tray Finish Adjustment	Code	Price £ Exc. VAT	Price £ Inc. VAT
900+	880-900	A0611Y0	1672.50	2007.00
1000+	980-1000	A0611RF	1596.67	1916.00
1100+	1080-1100	A0611SF	1705.83	2047.00
1200+	1180-1200	A0611TF	1730.00	2076.00
1400+	1380-1400	A0611UF	2172.50	2607.00
1600+	1580-1600	A0611VF	2128.33	2554.00
1700+	1680-1700	A0611WF	2325.83	2791.00

#### Optional Side Panel

Size	Tray Finish Adjustment	Code	Price £ Exc. VAT	Price £ Inc. VAT
760	740-760	A0607B0	748.33	898.00
800	780-800	A0607D0	748.33	898.00
900	880-900	A0607E0	748.33	898.00

Please note: Moving panel door must close onto the Side Panel. For wetroom installation, please reduce tray finish adjustment by 20mm.

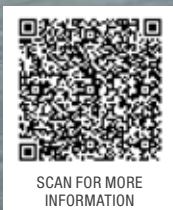

Hinge and Inline with Side Panel





*Pivot and Inline Door with Side Panel / Shown as Right Hand (R)*

**Technical drawing**

**Pivot and Inline Door a Recess**

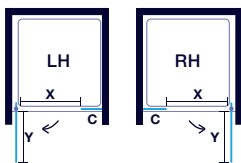

C: Fixed Panel  
Y: Door Swing  
X: Door Opening

**Pivot and Inline Door in Recess**

Enclosure Size	Door Size	Inline Size	X	Y	C
1000	<b>800</b>	<b>200</b>	682	680	218
1100	<b>800</b>	<b>300</b>	682	680	318
	900	200	782	780	218
1200	<b>800</b>	<b>400</b>	682	680	418
	900	300	782	780	318
1300	1000	200	882	880	218
	<b>800</b>	<b>500</b>	682	680	518
1400	900	400	782	780	418
	1000	300	882	880	318
1500	<b>900</b>	<b>500</b>	782	780	518
	1000	400	882	880	418
1600	<b>1000</b>	<b>500</b>	882	880	518
	<b>800</b>	<b>700</b>	682	680	718
1700	<b>900</b>	<b>700</b>	782	780	718
	<b>1000</b>	<b>700</b>	882	880	718

**Pivot and Inline Door with Side Panel**

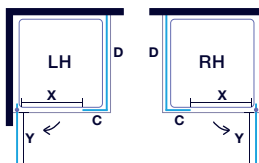

C: Fixed Panel  
Y: Door Swing  
X: Door Opening

**Pivot and Inline Door with Side Panel**

Enclosure Size	Door Size	Inline Size	X	Y	C
1000	800	200	682	680	225
1100	800	300	682	680	325
	900	200	782	780	225
1200	<b>800</b>	<b>400</b>	682	680	425
	900	300	782	780	325
1300	1000	200	882	880	225
	<b>800</b>	<b>500</b>	682	680	525
1400	900	400	782	780	425
	1000	300	882	880	325
1500	<b>900</b>	<b>500</b>	782	780	525
	1000	400	882	880	425
1600	<b>1000</b>	<b>500</b>	882	880	525
	<b>800</b>	<b>700</b>	682	680	725
1700	<b>900</b>	<b>700</b>	782	780	725
	<b>1000</b>	<b>700</b>	882	880	725

Extension profiles available. See page 153.

## Pivot Door & Inline Panel

This new addition to the 8 Series Frameless range brings with it choice and a range of size options to fit a varied space. This beautiful enclosure epitomises style and practicality.

### features

- » Height 1950mm
- » Solid chrome double handle
- » Cover caps
- » Space saving solution
- » Inward and outward opening swing
- » Concealed fixings
- » Reversible
- » Wetroom compatible

#### Pivot Door and Inline Panel in a Recess

Size	Size of Pivot Door	Inline Panels	Tray Finish Adjustment	Code	Price £ Exc. VAT	Price £ Inc. VAT
1000	<b>800</b>	<b>200</b>	960-1000	S8FPI1002H	1208.33	1450.00
1100	<b>800</b>	<b>300</b>	1060-1100	S8FPI1103H	1238.33	1486.00
	900	200		S8FPI1102H	1238.33	1486.00
1200	<b>800</b>	<b>400</b>	1160-1200	S8FPI1204H	1268.33	1522.00
	900	300		S8FPI1203H	1268.33	1522.00
	1000	200		S8FPI1202H	1268.33	1522.00
** 1300	<b>800</b>	<b>500</b>	1260-1300	S8FPI1305H	1299.17	1559.00
	900	400		S8FPI1304H	1299.17	1559.00
	1000	300		S8FPI1303H	1299.17	1559.00
1400	<b>900</b>	<b>500</b>	1360-1400	S8FPI1405H	1329.17	1595.00
	1000	400		S8FPI1404H	1329.17	1595.00
1500	<b>1000</b>	<b>500</b>	1460-1500	S8FPI1505H	1359.17	1631.00
	<b>800</b>	<b>700</b>		S8FPI1507H	1359.17	1631.00
1600	<b>900</b>	<b>700</b>	1560-1600	S8FPI1607H	1391.67	1670.00
1700	<b>1000</b>	<b>700</b>	1660-1700	S8FPI1707H	1410.83	1693.00

Please Note: Items in bold are our recommended configurations. \*\*Available with TouchStone Tray Only

#### Optional Pivot Door and Inline Side Panel

Size	Tray Finish Adjustment	Code	Price £ Exc. VAT	Price £ Inc. VAT
760	735-755	S8FSP76IN	685.00	822.00
800	775-795	S8FSP80IN	685.00	822.00
900	875-895	S8FSP90IN	726.67	872.00

For wetroom installation, please reduce tray finish adjustment by 10mm.

For more information on the Side Panel refer to the Technical drawing page 26.



SCAN FOR MORE  
INFORMATION



*Inward Swing*

*Pivot and Inline / Overhead  
Shown with Side Panel*



*Outward Swing*

*Pivot and Inline / Overhead  
Shown with Side Panel*





8<sup>MM</sup>  
GLASS  
THICKNESS

LIFETIME  
GUARANTEE

MERSHIELD<sup>™</sup>  
STAYCLEAR

# 8 | series

Style, ingenious functionality.

This range of elegant 8mm glass shower enclosures offer a variety of shapes and sizes to suit your preference. Each product delivers a style expression that enhances the feeling of space in the bathroom. Built with ingenious functionality to guarantee a seamless and safe operation.



*Easy clean push & release double rollers*

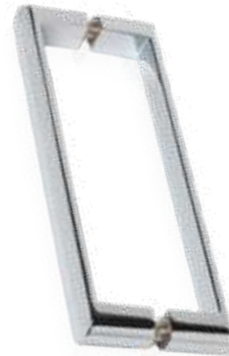

*Ergonomic handle designed for that effortless close.*



*Stunningly crafted transparent glass*

8 | series

SHOWER ENCLOSURES





Sliding Door with Side Panel / Shown as Right Hand (R)

Technical drawing

Sliding Door in Recess



Sliding Door with Side Panel

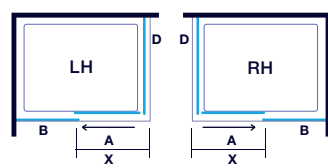

- A: Moving Panel
- B: Fixed Panel
- D: Side Panel
- X: Door Opening

Size	X	A	B
1000	390	470	440
1100	430	530	480
1200	470	580	530
1300	530	630	580
1400	570	680	630
1500	570	680	730
1600	570	680	830
1700	570	680	930



## Sliding Door

The 8 Series Sliding door is an impressive and highly engineered spacious enclosure with 8mm toughened safety glass, 1950mm high and smooth gliding action based on quick release double rollers for easy cleaning.

### features

- » Height 1950mm
- » Translucent seals
- » Concealed fixings
- » Full length chrome magnetic strips
- » Easy clean double rollers
- » Chrome handle
- » Reversible
- » Wetroom compatible

Sliding Door				
Size	Tray Finish Adjustment	Code	Price £ Exc. VAT	Price £ Inc. VAT
1000	950-990	M88231	1197.50	1437.00
1100	1050-1090	M88251	1175.00	1410.00
1200	1150-1190	M88241	1164.17	1397.00
1300	1250-1290	M88240	1428.33	1714.00
1400	1350-1390	M88291	1458.33	1750.00
1500	1450-1490	M88261	1509.17	1811.00
1600	1550-1590	M88271	1527.50	1833.00
1700	1650-1690	M88281	1601.67	1922.00

Please add 20mm to tray finish adjustment when using a Side Panel.

Optional Side Panel				
Size	Tray Finish Adjustment	Code	Price £ Exc. VAT	Price £ Inc. VAT
700	670-690	M82201	675.00	810.00
760	730-750	M82210	669.17	803.00
800	770-790	M82211	656.67	788.00
900	870-890	M82221	695.83	835.00
1000	970-990	M82231	777.50	933.00

Sliding door can be paired with 2 optional Side Panels  
For wetroom installation, please reduce tray finish adjustment by 20mm.

Optional Inline Panel				
Size	Tray Finish Adjustment	Code	Price £ Exc. VAT	Price £ Inc. VAT
150	130-150	M8P140	405.83	487.00
210	190-210	M8P2200	421.67	506.00

Inline panels can be fitted to either or both sides of Sliding Door - See page 154 for space solutions.

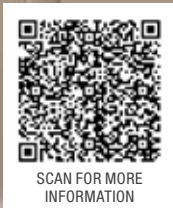

Sliding Door in Recess



## 1 Door Quadrant

With fresh curved lines and designer chrome handles, the 1 Door Quadrant exudes traditional style with a contemporary twist and a strong focus on expert engineering.

### features

- » Height 1950mm
- » Concealed fixings
- » Chrome design symmetry handle
- » Reversible
- » Wetroom compatible
- » Translucent seals

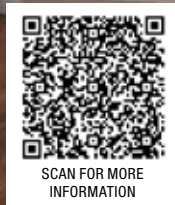

1 Door Offset Quadrant / Shown as Right Hand (R) 1400x800 size available



1 Door Quadrant

### 1 Door Quadrant

Size	Tray Finish Adjustment	Code	Price £ Exc. VAT	Price £ Inc. VAT
900 x 900	875-895	M83225	1469.17	1763.00

### 1 Door Offset Quadrant

900 x 760	875-895 / 735-755	M83222	1664.17	1997.00
1000 x 800	975-995 / 775-795	M83233	1664.17	1997.00
1200 x 800	1175-1195 / 775-795	M83243	1678.33	2014.00
1200 x 900	1175-1195 / 875-895	M83241	1678.33	2014.00
1400 x 800	1375-1395 / 775-795	M83244	1683.33	2020.00

Please add 20mm to Adjustment when using a Side Panel.

### MERLYN Dedicated Offset Quadrant Tray (1400x800)

Size	Code	Price £ Exc. VAT	Price £ Inc. VAT
1400 x 800	S148Q L or R	434.17	521.00

This tray is handed please choose L for left and R for right when ordering.  
Please Note: The 1400x800mm tray is not an Touchstone Tray, it is a dedicated single skinned tray.  
For wetroom installation, please reduce tray finish adjustment by 20mm.

### Technical drawing

#### 1 Door Offset Quadrant

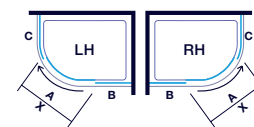

A: Moving Panel  
B: Fixed Panel  
C: Curved Panel  
X: Door Opening

Size	X	B	C
900 x 760	420	465	275
1000 x 800	425	520	375
1200 x 800	425	520	575
1200 x 900	480	540	575
1400 x 800	425	520	775

#### 1 Door Quadrant

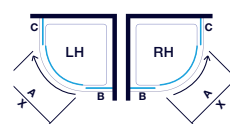

A: Moving Panel  
B: Fixed Panel  
C: Curved Fixed Panel  
X: Door Opening

Size	X	B	C
900 x 900	480	540	275



## 2 Door Quadrant

With fresh curved lines and designer chrome handles, the 2 Door Quadrant exudes traditional style with a contemporary twist and a strong focus on expert engineering.

### features

- » Height 1950mm
- » Translucent seals
- » Concealed fixings
- » Easy clean double rollers
- » Chrome design symmetry handle
- » Reversible
- » Wetroom compatible

8 | SERIES

SHOWER ENCLOSURES



2 Door Quadrant

### 2 Door Quadrant

Size	Tray Finish Adjustment	Code	Price £ Exc. VAT	Price £ Inc. VAT
800	775-795	M83211	1342.50	1611.00
900	875-895	M83221	1342.50	1611.00
1000	975-995	M83231	1647.50	1977.00

For wetroom installation, please reduce tray finish adjustment by 20mm.

### Technical drawing

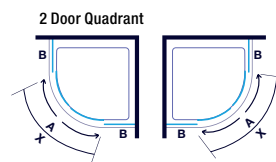

A: Moving Panels  
 B: Fixed Panel  
 X: Door Opening

All sizes to suit a 550mm Radius Tray.  
 Extension profiles available.  
 See page 153.

Size	X	A	B
800	410	385	220
900	540	385	320
1000	540	385	420



## Infold Door

This door is the epitome of space saving solutions without compromising on the beautiful lines of the glass door. Pair this 1950mm high 8 Series door with the minimalist optional Side Panel and this enclosure becomes ideal for any corner setting.

### features

- » Height 1950mm
- » Concealed fixings
- » Chrome design symmetry handle
- » Reversible
- » Wetroom compatible
- » Translucent seals

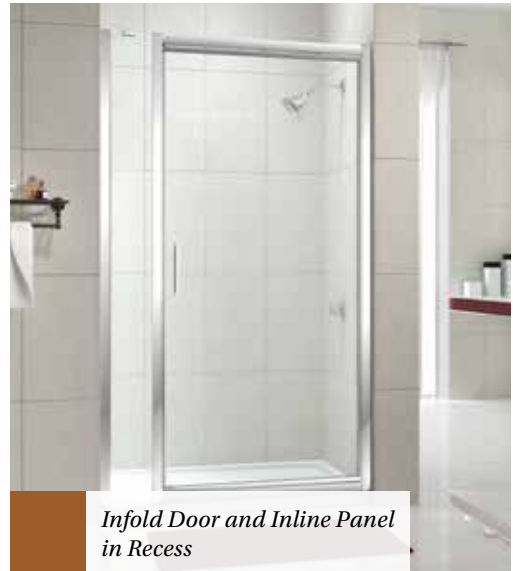
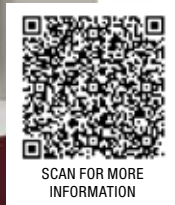

Infold Door with Side Panel / Shown as Right Hand (R)

Infold Door and Inline Panel in Recess

### Infold Door

Size	Tray Finish Adjustment	Code	Price £ Exc. VAT	Price £ Inc. VAT
700	650-690	M84401	1169.17	1403.00
760	710-750	M84410	1177.50	1413.00
800	750-790	M84411	1179.17	1415.00
900	850-890	M84421	1195.83	1435.00
1000	950-990	M84431	1325.83	1591.00

Please add 20mm to tray finish adjustment when using a Side Panel.

### Optional Side Panel

Size	Tray Finish Adjustment	Code	Price £ Exc. VAT	Price £ Inc. VAT
700	670-690	M82201	675.00	810.00
760	730-750	M82210	669.17	803.00
800	770-790	M82211	656.67	788.00
900	870-890	M82221	695.83	835.00
1000	970-990	M82231	777.50	933.00

For wetroom installation, please reduce tray finish adjustment by 20mm.

### Optional Inline Panel

Size	Tray Finish Adjustment	Code	Price £ Exc. VAT	Price £ Inc. VAT
150	130-150	M8P140	405.83	487.00
210	190-210	M8P2200	421.67	506.00

Inline Panels can be fitted to either or both sides of Infold Door - See page 154 for space solutions.

### Technical drawing

Infold Door in Recess

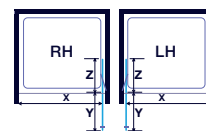

Infold Door with side Panel

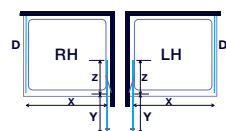

D: Side Panel

Y: Outside Door Swing

Z: Inside Door Swing

X: Door Opening

Extension profiles available. See page 153.

Size	X	Y	Z
700	505	200	355
760	565	260	355
800	605	300	355
900	705	400	355
1000	805	500	355



## Hinge Door

A practical choice for larger en suites or smaller bathrooms. The Hinge Door offers a highly specified and versatile option, making it suitable for a large range of spaces.

### features

- » Height 1950mm
- » Concealed fixings
- » Extended length chrome design symmetry handle
- » Translucent seals
- » Wetroom compatible
- » Minimalist exposed glass edge
- » Signature hinges with internal flush fixings
- » Reversible
- » Double bales catch closing with definitive "Clunk" close



Hinge Door in Recess / Shown as Right Hand (R)



SCAN FOR MORE INFORMATION



Hinge Door with Side Panel

### Hinge Door

Size	Tray Finish Adjustment	Code	Price £ Exc. VAT	Price £ Inc. VAT
700	650-690	M81201	1103.33	1324.00
760	710-750	M81210	1105.83	1327.00
800	750-790	M81211	1095.83	1315.00
900	850-890	M81221	1213.33	1456.00
1000	950-990	M81231	1284.17	1541.00

Please add 20mm to tray finish adjustment when using a Side Panel.

### Optional Side Panel

Size	Tray Finish Adjustment	Code	Price £ Exc. VAT	Price £ Inc. VAT
700	670-690	M82201	675.00	810.00
760	730-750	M82210	669.17	803.00
800	770-790	M82211	656.67	788.00
900	870-890	M82221	695.83	835.00
1000	970-990	M82231	777.50	933.00

For wetroom installation, please reduce tray finish adjustment by 20mm.

### Optional Inline Panel

Size	Tray Finish Adjustment	Code	Price £ Exc. VAT	Price £ Inc. VAT
150	130-150	M8P140	405.83	487.00
210	190-210	M8P2200	421.67	506.00

Inline panels can be fitted to either or both sides of Hinge Door - See page 154 for space solutions. Please Note: Moving panel door must close onto the Side Panel.

### Technical drawing

Hinge Door in Recess

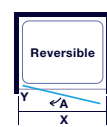

Hinge Door with Side Panel

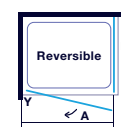

A: Moving Panel  
D: Side Panel  
Y: Door swing  
X: Door Opening

Extension profiles available. See page 153.

Size	X	Y
700	550	550
760	610	610
800	650	650
900	750	750
1000	850	850





6<sup>MM</sup>  
GLASS  
THICKNESS

LIFETIME  
GUARANTEE

MERSHIELD™  
STAYCLEAR

# 6 | series

## Affordable quality

The 6 series range is the perfect choice if you are looking for a showering solution that is affordable yet incredibly stylish. The MERLYN trademark Mershield Stayclear™ and lifetime guarantee come as standard. This range delivers on style and functionality.



*Easy clean push & release  
double rollers*



*Discreet inside handle and larger  
external handle for easy closing.*



*Stunningly crafted  
transparent glass*



### Technical drawing

Sliding Door in Recess

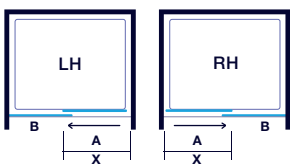

Sliding Door with side Panel

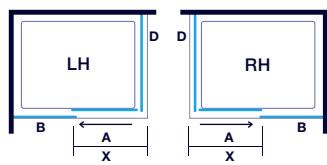

- A: Moving Panel
- B: Fixed Panel
- D: Side Panel
- X: Door Opening

Extension profiles available. See page 153.

Size	X	A	B
1000	380	492	420
1100	430	542	470
1200	480	592	520
1400	580	692	620
1500	580	692	720
1600	580	692	820
1700	580	692	920



## Sliding Door

The 6 Series Sliding Door has been enhanced with designer handles and quick release double rollers for easy access cleaning. With exceptionally smooth opening, this enclosure which stands at 1900mm high is affordable yet incredibly stylish.

### features

- » Height 1900mm
- » Translucent seals
- » Full length chrome magnetic strips
- » Easy clean double rollers
- » Double handed
- » Can be used with 2 optional minimalist Side Panels
- » Reversible
- » Wetroom compatible

#### Sliding Door

Size	Tray Finish Adjustment	Code	Price £ Exc. VAT	Price £ Inc. VAT
1000	950-1000	M68231	854.17	1025.00
1100	1050-1100	M68251	854.17	1025.00
1200	1150-1200	M68241	830.83	997.00
1400	1350-1400	M68291	1010.00	1212.00
1500	1450-1500	M68261	1075.83	1291.00
1600	1550-1600	M68271	1136.67	1364.00
1700	1650-1700	M68281	1136.67	1364.00

\*Order code for ordering shower enclosure and tray.  
Please add 20mm to tray finish adjustment when using a Side Panel.

#### Optional Side Panel

Size	Tray Finish Adjustment	Code	Price £ Exc. VAT	Price £ Inc. VAT
700	680-705	M62201N	490.83	589.00
760 / 800	745-790	M62211N	430.00	516.00
900	875-900	M62221N	457.50	549.00
1000	975-1000	M62231N	520.83	625.00

Sliding door can be paired with 2 optional Side Panels  
For wetroom installation, please reduce tray finish adjustment by 20mm.

#### Optional Inline Panel

Size	Tray Finish Adjustment	Code	Price £ Exc. VAT	Price £ Inc. VAT
140	115-140	M6I125	385.00	462.00
215	190-215	M6I200	400.83	481.00

Inline panels can be fitted to either or both sides of Sliding Door. See page 155 for space solutions.



SCAN FOR MORE INFORMATION



Sliding Door in Recess



## Quadrant Doors

The 6 Series Quadrants have it all – 1900mm high with a beautifully curved chrome frame, 6mm toughened glass, designer handles and quick release double rollers for easy access to clean – stylish yet very affordable.

### features

- » Height 1900mm
- » Translucent seals
- » Easy clean double rollers
- » Double handed
- » Reversible
- » Wetroom compatible

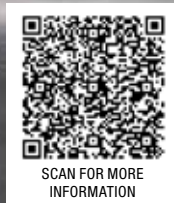

1 Door Quadrant / Shown as Left Hand (L)



2 Door Quadrant

### 1 Door Quadrant

Size	Tray Finish Adjustment	Code	Price £ Exc. VAT	Price £ Inc. VAT
900 x 900	875-900	M63225	1065.00	1278.00

### 1 Door Offset Quadrant

900 x 760	875-900 / 735-760	M63222	1238.33	1486.00
1000 x 800	975-1000 / 775-800	M63233	1405.83	1687.00
1200 x 800	1175-1200 / 775-800	M63243	1403.33	1684.00
1200 x 900	1175-1200 / 875-900	M63241	1405.83	1687.00

For wetroom installation, please reduce tray finish adjustment by 20mm.

### 2 Door Quadrant

Size	Tray Finish Adjustment	Code	Price £ Exc. VAT	Price £ Inc. VAT
800	775-800	M63211	943.33	1132.00
900	875-900	M63221	943.33	1132.00
1000	975-1000	M63231	1133.33	1360.00

For wetroom installation, please reduce tray finish adjustment by 20mm.

### Technical drawing

#### 1 Door Quadrant

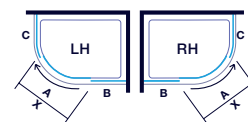

A: Moving Panel  
B: Fixed Panel  
C: Fixed Panel  
X: Door Opening  
All sizes to suit a 550mm Radius Tray. Extension profiles available. See page 153.

Size	X	B	C
900 x 760	405	460	280
900 x 900	480	540	250
1000 x 800	430	495	380
1200 x 800	430	495	580
1200 x 900	480	540	580

#### 2 Door Quadrant

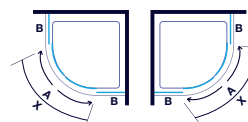

Size	X	B
800	375	225
900	540	325
1000	540	425

A: Moving Panel  
B: Fixed Panel  
X: Door Opening

## Pivot Door

The 6 Series Pivot Door has been enhanced with designer handles and quick release double rollers for easy access cleaning. With exceptionally smooth opening, this enclosure which stands at 1900mm high is affordable yet incredibly stylish.

### features

- » Height 1900mm
- » Translucent seals
- » Full length chrome
- » Magnetic strips
- » Double handed
- » Reversible
- » Wetroom compatible



Pivot Door with Side Panel / Shown as Left Hand (L)

### Pivot Door

Size	Tray Finish Adjustment	Code	Price £ Exc. VAT	Price £ Inc. VAT
700	670-720	M61201N	615.00	738.00
760/800	740-790	M61211N	692.50	831.00
900	850-900	M61221N	713.33	856.00
1000	950-1000	M61231N	765.83	919.00

Please add 10mm to tray finish adjustment when using a Side Panel.

### Optional Side Panel

Size	Tray Finish Adjustment	Code	Price £ Exc. VAT	Price £ Inc. VAT
700	680-705	M62201N	490.83	589.00
760 / 800	745-790	M62211N	430.00	516.00
900	875-900	M62221N	457.50	549.00
1000	975-1000	M62231N	520.83	625.00

Pivot door can be paired with 1 optional Side Panels For wetroom installation, please reduce tray finish adjustment by 20mm.

### Optional Inline Panel

Size	Tray Finish Adjustment	Code	Price £ Exc. VAT	Price £ Inc. VAT
140	680-705	M61125	385.00	462.00
215	745-790	M61200	400.83	481.00

Inline panels can be fitted to either or both sides of pivot door. See page 155 for space solutions.

### Technical drawing

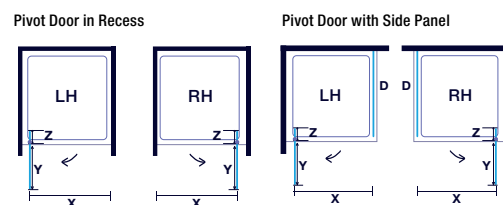

Size	X	Y	Z
700	410	410	120
760 / 800	480	480	120
900	590	590	120
1000	690	690	120

X: Door Opening  
Y: Outside Door Swing  
Z: Inside Door Swing  
Note: Side Panel is 6mm glass  
Extension profiles available. See page 153.

## Bifold Door

Where space is at a premium the 6 Series Bifold is the ultimate solution. This new version of a classic shape, offers a sleek frameless design with a discreet chrome hinge detail.

### features

- » Height 1900mm
- » Discreet chrome bifold hinge
- » Sleek frameless door design
- » Reversible
- » Wetroom compatible

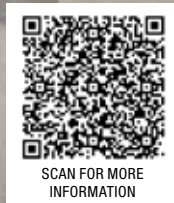

Bifold Door with Side Panel / Shown as Right Hand (R)



Bifold Door in Recess

### Bifold Door

Size	Tray Finish Adjustment	Code	Price £ Exc. VAT	Price £ Inc. VAT
700	670-720	M67201N	955.00	1146.00
760 / 800	740-790	M67211N	937.50	1125.00
900	850-900	M67221N	1023.33	1228.00
1000	950-1000	M67231N	1076.67	1292.00

Can be used with 2 optional minimalist Side Panels.  
Please add 10mm to tray finish adjustment when using a Side Panel.

### Optional Side Panel

Size	Tray Finish Adjustment	Code	Price £ Exc. VAT	Price £ Inc. VAT
700	680-705	M62201N	490.83	589.00
760 / 800	745-790	M62211N	430.00	516.00
900	875-900	M62221N	457.50	549.00
1000	975-1000	M62231N	520.83	625.00

For wetroom installation, please reduce tray finish adjustment by 20mm.

### Optional Inline Panel

Size	Tray Finish Adjustment	Code	Price £ Exc. VAT	Price £ Inc. VAT
140	115-140	M6I125	385.00	462.00
215	190-215	M6I200	400.83	481.00

Inline Panels can be fitted to either or both sides of Bifold Door. See page 155 for space solutions.

### Technical drawing

Bifold Door in Recess

Bifold Door with Side Panel

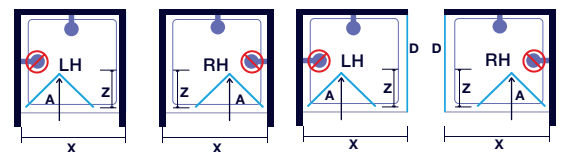

A: Moving Panel  
X: Door Opening  
Z: Width of panel when folded

Extension profiles available. See page 153.

Size	X	Z
700	420	295
760 / 800	490	330
900	600	385
1000	650	430





## Corner Door

The 6 Series Corner door is a functional and contemporary enclosure. It is the perfect solution for bijoux en suites or awkward spaces as the doors slide back within the confines of the shower itself.

### features

- » Height 1900mm
- » Translucent seals
- » Easy clean double rollers
- » Double handed
- » Double sliding doors
- » Reversible
- » Wetroom compatible



Corner Door with side Panel

### Corner Door

Size	Tray Finish Adjustment	Code	Price £ Exc. VAT	Price £ Inc. VAT
800	775-800	M65211	1080.83	1297.00
900	875-900	M65221	1190.00	1428.00

For wetroom installation, please reduce tray finish adjustment by 20mm.

### Technical drawing

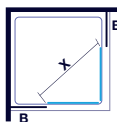

Size	X	B
800	395	310
900	465	360

X: Door Opening  
B: Fixed Panel  
Extension profiles available. See page 153.



*Colour Options...*



Standard Chrome



Matt Black

8<sub>MM</sub>  
GLASS  
THICKNESS

20 YEARS  
GUARANTEE

MERSHIELD™  
STAYCLEAR

## IONIC | Essence Frameless

Style, seamless precision

Ionic Essence is truly unique in its appearance with its fusion of style and precision engineering. We have spent a great deal of time developing this stylish range that stays true to the basic Ionic principle — built to last.

Available in both Chrome & Black



*Stunningly crafted transparent glass*



*Double handles*



*Designer handles*



*Designer hinge with concealed pivot*





Sliding Door in Recess / Shown as Left Hand (L)

### Technical drawing

Sliding Door in Recess



A: Moving Panel  
B: Fixed Panel  
X: Door Opening

Size	X	B
1000	365	465
1100	415	515
1200	465	565
1400	565	665
1700	565	965

Sliding Door with Side Panel

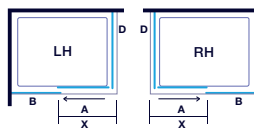

A: Moving Panel  
B: Fixed Panel  
D: Side Panel  
X: Door Opening

Size	X	B
1000	350	465
1100	400	515
1200	450	565
1400	550	665
1700	550	965



## Sliding Door - Chrome

The Ionic Essence Frameless Sliding Door is offered in a variety of size, ranging from 1000mm to 1700mm, making it an excellent fit for shower spaces of medium to large dimensions. Featuring a frameless design, this minimalist door helps create a real sense of space in your bathroom.

### features

- » Height 2000mm
- » Concealed fixing
- » Reversible
- » Smooth action extra strong rollers
- » Stunning frameless design
- » Discreet deflection seal on luna rail for increased water retention
- » Minimalist designer rail with concealed rollers both inside and outside
- » Chrome double handle

#### Sliding Door

Size	Adjustment in Recess	Adjustment with Side Panel	Code	Price £ Exc. VAT	Price £ Inc. VAT
1000	950-990	940 - 965	A0104A0	1000.00	1200.00
1100	1050-1090	1040-1065	A0104B0	1020.83	1225.00
1200	1150-1190	1140 - 1165	A0104IH	1041.67	1250.00
1400	1350-1390	1340 - 1365	A0104DH	1125.00	1350.00
1700	1650-1690	1640 - 1665	A0104HH	1250.00	1500.00

#### Optional Side Panel

Size	Adjustment	Code	Price £ Exc. VAT	Price £ Inc. VAT
800	760-785	A0107I0	541.67	650.00
900	860-885	A0107J0	562.50	675.00



SCAN FOR MORE INFORMATION



Sliding Door with Side Panel



Sliding Door with Side Panel / Shown as Left Hand (L)

Technical drawing

Sliding Door in Recess

Size	X	B
1200	468	560
1400	568	660
1500	568	760
1700	568	960

- A: Moving Panel
- B: Fixed Panel
- D: Side Panel
- X: Door Opening

Sliding Door with Side Panel

Size	X	B
1200	450	560
1400	550	660
1500	550	760
1700	550	960





## Sliding Door - Black

The Ionic Essence Frameless Black Sliding Door brings with it the smoothest rolling action possible in 8mm glass. With stunning designer features and its sleek, minimal matte black frame, this enclosure symbolises style that will stand out in your bathroom space.

### features

- » Height 2000mm
- » Black seals
- » Concealed fittings
- » Smooth action roll
- » Reversible
- » Anodised aluminium matte black finish - more durable than powder coating
- » Wetroom compatible

#### Sliding Door

Size	Adjustment in Recess	Adjustment with Side Panel	Code	Price £ Exc. VAT	Price £ Inc. VAT
1200	1150 - 1190	1140-1165	BLKFSL1200H	1041.67	1250.00
1400	1350 - 1390	1340-1365	BLKFSL1400H	1125.00	1350.00
1500	1450 - 1490	1440-1465	BLKFSL1500H	1166.67	1400.00
1700	1650 - 1690	1640-1665	BLKFSL1700H	1250.00	1500.00

\*Please allow 5mm - 15mm step-in on the tray. See table below for waste cap options.

#### Optional Side Panel

Size	Adjustment	Code	Price £ Exc. VAT	Price £ Inc. VAT
800	760 - 785	BLKFSP800	541.67	650.00
900	860 - 885	BLKFSP900	562.50	675.00

#### Additional Options

Size	Add-On	Code	Price £ Exc. VAT	Price £ Inc. VAT
2000	Extension Profile	BLKFSLEXT	100.00	120.00

Extension profile: extra 20mm. Extension Profile is matte black.

#### Tray Accessories

Size	Add-On	Code	Price £ Exc. VAT	Price £ Inc. VAT
-	White Waste Cap	DWASCAPWHT	20.00	24.00

Waste Cap for Touchstone, Mstone & Upstand trays comes in standard chrome. Please use code above for white waste cap. Level25 tray waste cap comes in standard white.



SCAN FOR MORE INFORMATION

*The black colour layer is not applied to the surface like paint or plating, but is fully integrated with the underlying aluminium substrate, so it cannot chip or peel.*



Sliding Door in Recess



1 Door Offset Quadrant / Shown as Left Hand (L)

Technical drawing

1 Door Quadrant



A: Moving Panel  
 B: Fixed Panel  
 C: Fixed Panel  
 X: Door Opening

Size	X	B	C
900	475	550	290

1 Door Offset Quadrant

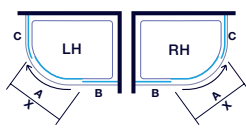

A: Moving Panel  
 B: Fixed Panel  
 C: Curved Fixed Panel  
 X: Door Opening

Size	X	B	C
1200 x 900	475	550	590



## 1 Door Quadrant - Chrome

With an extra smooth roller action, the Ionic Essence Frameless Quadrant Door combines clean lines and subtle curves, for a spacious showering space.

### features

- » Height 2000mm
- » Concealed fixing
- » Smooth action extra strong rollers
- » Chrome double handle
- » Stunning frameless design
- » Minimalist designer rail with concealed rollers both inside and out
- » Discreet deflector seal on luna rail for increased water retention
- » Extra strong rollers with additional guide to added smoothness.
- » Door is handed - order Left Hand (L) or Right Hand (R)

#### 1 Door Quadrant

Size	Adjustment	Code	Price £ Exc. VAT	Price £ Inc. VAT
900 x 900	860-885	A0101MH <b>L</b>	1166.67	1400.00
900 x 900	860-885	A0101NH <b>R</b>	1166.67	1400.00

#### 1 Door Offset Quadrant

1200 x 900	860-885 / 1160-1185	A0101KH <b>L</b>	1291.67	1550.00
1200 x 900	860-885 / 1160-1185	A0101LH <b>R</b>	1291.67	1550.00



SCAN FOR MORE INFORMATION



1 Door Quadrant





1 Door Offset Quadrant / Shown as Right Hand (R)

Technical drawing

1 Door Quadrant

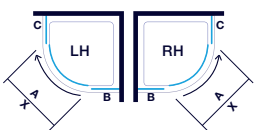

A: Moving Panel  
 B: Fixed Panel  
 C: Fixed Panel  
 X: Door Opening

Size	X	B	C
900	483	558	285

1 Door Offset Quadrant

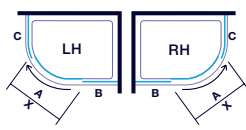

A: Moving Panel  
 B: Fixed Panel  
 C: Curved Fixed Panel  
 X: Door Opening

Size	X	B	C
1200 x 900	483	558	585



## 1 Door Quadrant - Black

With an extra smooth roller action, the Ionic Essence Frameless Quadrant Door combines clean lines and subtle curves, for a spacious showering space.

### features

- » Height 2000mm
- » Concealed fixing
- » Smooth action extra strong rollers
- » Matt Black double handle
- » Stunning frameless design
- » Minimalist designer rail with concealed rollers both inside and out
- » Discreet deflector seal on luna rail for increased water retention
- » Extra strong rollers with additional guide to added smoothness.
- » Door is handed - order Left Hand (L) or Right Hand (R)

#### 1 Door Quadrant

Size	Adjustment	Code	Price £ Exc. VAT	Price £ Inc. VAT
900 x 900	860-885	BLKFQ90 L	1166.67	1400.00
900 x 900	860-885	BLKFQ90 R	1166.67	1400.00

#### 1 Door Offset Quadrant

1200 x 900	860-885 / 1160-1185	BLKFQ129 L	1291.67	1550.00
1200 x 900	860-885 / 1160-1185	BLKFQ129 R	1291.67	1550.00

#### Additional Options

Size	Add-On	Code	Price £ Exc. VAT	Price £ Inc. VAT
2000	Extension Profile	BLKFSLEXT	100.00	120.00

Extension profile: extra 20mm. Extension Profile is matte black.

#### Tray Accessories

Size	Add-On	Code	Price £ Exc. VAT	Price £ Inc. VAT
-	White Waste Cap	DWASCAPWHT	20.00	24.00

Waste Cap for Touchstone, Mstone & Upstand trays comes in standard chrome. Please use code DWASCAPWHT for white waste cap. Level25 tray waste cap comes in standard white.



SCAN FOR MORE INFORMATION



1 Door Quadrant / Shown as Left Hand (L)

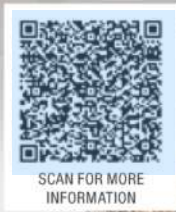

SCAN FOR MORE INFORMATION

**Hinge and Inline in Recess**

Hinge & Inline Door in Recess				
Size	Adjustment	Code	Price £ Exc. VAT	Price £ Inc. VAT
760	720-760	A0111F0	1000.00	1200.00
800	760-800	A0111C0	1020.83	1225.00
800+	800-840	A0111M0	1020.83	1225.00
900	860-900	A0111D0	1041.67	1250.00
900+	900-940	A0111N0	1041.67	1250.00
1000	960-1000	A0111E0	1083.33	1300.00
1000+	1000-1040	A0111O0	1083.33	1300.00
1100	1060-1100	A0111JH	1104.17	1325.00
1100+	1100-1140	A0111JF	1104.17	1325.00
1200	1160-1200	A0111GH	1125.00	1350.00
1200+	1200-1240	A0111GF	1125.00	1350.00
1400	1360-1400	A0111HH	1166.67	1400.00
1400+	1400-1440	A0111HF	1166.67	1400.00
1500	1460-1500	A0111KH	1208.33	1450.00
1500+	1500-1540	A0111KF	1208.33	1450.00

Size	X	Y	B
760	440	460	160
800	440	460	200
800+	480	500	200
900	490	510	250
900+	530	550	250
1000	540	560	300
1000+	580	600	300
1100	590	610	350
1100+	630	650	350
1200	590	610	450
1200+	630	650	450
1400	590	610	650
1400+	630	650	650
1500	590	610	750
1500+	630	650	750

**Technical drawing**

**Hinge and Inline Door in Recess**

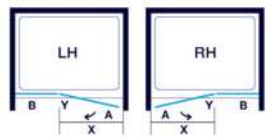

A: Moving Panel      Y: Door Swing  
 B: Fixed Panel        X: Door Opening

Please note : Side panels should only be used with + sizes (not standard sizes).





## Hinge & Inline Panel in Recess and with Side Panel - Chrome only

Offered in sizes ranging from 760mm to 1500mm, the Ionic Essence Frameless Hinge and Inline provides a tailored solution for your needs. With its elegant frameless design, this door adds a touch of refinement to any bathroom style.

### features

- » Height 2000mm
- » Concealed fixings
- » Solid chrome double handle symmetrical to hinges
- » Solid designer hinge with concealed pivot point
- » Reversible
- » Stunning frameless design



Hinge and Inline with Side Panel

#### Hinge & Inline Door with Side Panel

Size	Adjustment	Code	Price £ Exc. VAT	Price £ Inc. VAT
800+	770-790	A0111M0	1020.83	1225.00
900+	870-890	A0111N0	1041.67	1250.00
1000+	970-990	A0111O0	1083.33	1300.00
1100+	1070-1090	A0111JF	1104.17	1325.00
1200+	1170-1190	A0111GF	1125.00	1350.00
1400+	1370-1390	A0111HF	1166.67	1400.00
1500+	1470-1490	A0111KF	1208.33	1450.00

#### Optional Side Panel

Size	Adjustment	Code	Price £ Exc. VAT	Price £ Inc. VAT
800	750-790	A0107G0	541.67	650.00
900	850-890	A0107H0	562.50	675.00

### Technical drawing

#### Hinge and Inline Door with Side Panel

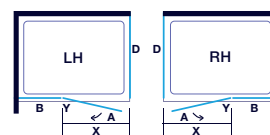

- A: Moving Panel
- B: Fixed Panel
- D: Side Panel
- Y: Door Swing
- X: Door Opening

Please note : Side panels should only be used with + sizes (not standard sizes).

Size	X	Y	B
800+	480	500	200
900+	530	550	250
1000+	580	600	300
1100+	630	650	350
1200+	630	650	450
1400+	630	650	650
1500+	630	650	750



Hinge and Inline with Side Panel / Shown as Right Hand (R)

### Technical drawing

Hinge and Inline Door a Recess

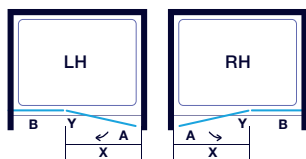

Hinge and Inline Door with Side Panel

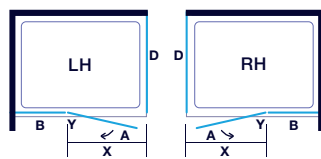

A: Moving Panel  
B: Fixed Panel  
D: Side Panel

Y: Door Swing  
X: Door Opening  
+ Sizes indicate opening when fitted with side panel

Size	X	Y	B
900	490	520	250
900+	530	560	250
1000	540	570	300
1000+	580	610	300
1200	590	620	450
1200+	630	660	450
1400	590	620	670
1400+	630	660	670

## Hinge and Inline - Black

This frameless enclosure fuses style and elegance with practical functionality. The Ionic Essence Frameless Hinge & Inline enclosure creates a fabulous contrast feature within your bathroom that will be the envy of all who visit.

### features

- » Height 2000mm
- » Black seals
- » Luxury metal handle
- » Sleek designer bracing bar
- » Anodised aluminium matte black finish - more durable than powder coating
- » Reversible

#### Hinge and Inline in Recess (+ codes can only be used with Side Panels)

Size	Adjustment	Code	Price £ Exc. VAT	Price £ Inc. VAT
900	860 - 900	BLKH900REC	1041.67	1250.00
900+	900 - 940	BLKH900SP	1041.67	1250.00
1000	960 - 1000	BLKH1000REC	1083.33	1300.00
1000+	1000 - 1040	BLKH1000SP	1083.33	1300.00
1200	1160 - 1200	BLKH1200RECH	1125.00	1350.00
1200+	1200 - 1240	BLKH1200SPH	1125.00	1350.00
1400	1360 - 1400	BLKH1400RECH	1166.67	1400.00
1400+	1400 - 1440	BLKH1400SPH	1166.67	1400.00

#### Hinge and Inline with Side Panel (+ codes can only be used with Side Panels)

Size	Adjustment	Code	Price £ Exc. VAT	Price £ Inc. VAT
900+	870 - 890	BLKH900SP	1041.67	1250.00
1000+	970 - 990	BLKH1000SP	1083.33	1300.00
1200+	1170 - 1190	BLKH1200SPH	1125.00	1350.00
1400+	1370 - 1390	BLKH1400SPH	1166.67	1400.00

#### Optional Side Panel to match + sizes only

Size	Adjustment	Code	Price £ Exc. VAT	Price £ Inc. VAT
760	730 - 750	BLKHSP760	520.83	625.00
800	770 - 790	BLKHSP800	541.67	650.00
900	870 - 890	BLKHSP900	562.50	675.00

#### Additional Options

Size	Add-On	Code	Price £ Exc. VAT	Price £ Inc. VAT
2000	Hinge & Inline Extension Profile	BLKHEXT	100.00	120.00

Extension profile: extra 20mm. Extension Profile is matte black.

#### Tray Accessories

Size	Size	Code	Price £ Exc. VAT	Price £ Inc. VAT
-	-	DWASCAPWHT	20.00	24.00

Waste Cap for Touchstone, Mstone & Upstand trays comes in standard chrome. Please use code DWASCAPWHT for white waste cap. Level25 tray waste cap comes in standard white.



SCAN FOR MORE  
INFORMATION



Stabilising Bar





Framed Square Hinge & Inline Door / Shown as Left Hand (L)

Door in Recess

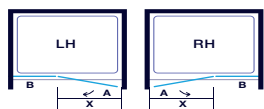

Size	X	B
900	564	208
1000	664	208
1200	664	408
1400	664	608

Door with Side Panel

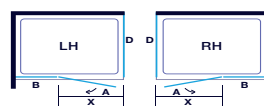

Size	D
800	770
900	870

A: Moving Panel  
 B: Fixed Panel  
 D: Side Panel  
 X: Door Opening



## Framed Square Hinge & Inline Door - Black

The Framed Square Hinge and Inline Door is here to transform your bathroom. This enclosure creates a fabulous style contrast within your bathroom that will be the envy of all who visit.

### features

- » Height 2000mm
- » Concealed fixing
- » Reversible
- » Quick & easy installation

#### Framed Square Hinge & Inline Door

Size	Adjustment in Recess	Adjustment with Side Panel	Code	Price £ Exc. VAT	Price £ Inc. VAT
900	850 - 890	858 - 878	AFHI90MB	1276.00	1531.20
1000	950 - 990	958 - 978	AFHI10MB	1276.00	1531.20
1200	1150 - 1190	1158 - 1178	AFHI12MB	1382.00	1658.40
1400	1350 - 1390	1358 - 1378	AFHI14MB	1735.00	2082.00

Door is reversible

#### Optional Side Panel

Size	Adjustment	Code	Price £ Exc. VAT	Price £ Inc. VAT
800	770-790	AFHI80SPMB	541.67	650.00
900	870-890	AFHI90SPMB	562.50	675.00

#### Tray Accessories

Size	Add-On	Code	Price £ Exc. VAT	Price £ Inc. VAT
-	White Waste Cap	DWASCAPWHT	20.00	24.00

Waste Cap for Touchstone, Mstone & Upstand trays comes in standard chrome. Please use code above for white waste cap. Level25 tray waste cap comes in standard white.



SCAN FOR MORE  
INFORMATION





8<sup>MM</sup>  
GLASS  
THICKNESS

20 YEARS  
GUARANTEE

MERSHIELD<sup>™</sup>  
STAYCLEAR

## IONIC | Essence Framed

### Precision engineering

Precision engineered to suit every bathroom space. Colour matched chrome magnetic seals and concealed fittings to ensure it looks great all around and quick release double rollers which makes it hassle-free to clean.



*Easy clean push & release double rollers*





Sliding Door with Side Panel / Shown as Right Hand (R)

Technical drawing

Sliding Door in Recess



Sliding Door with Side Panel

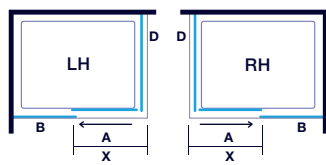

- A: Moving Panel
- B: Fixed Panel
- D: Side Panel
- X: Door Opening

Size	X	B
1000	360	380
1100	410	430
1200	460	480
1400	560	580
1700	560	880



## Sliding Door

Exuding both style and seamless motion, the Ionic Essence Framed Sliding Door will add a focal point to any bathroom aesthetic.

### features

- » Height 1900mm
- » Concealed fixing
- » Reversible
- » Smooth action extra strong rollers
- » Easy clean quick release rollers
- » Chrome finish including top cover caps
- » Chrome magnetic strips

Sliding Door				
Size	Adjustment	Code	Price £ Exc. VAT	Price £ Inc. VAT
1000	930-990	DWH04A0	859.17	1031.00
1100	1030-1090	DWH04B1	867.50	1041.00
1200	1130-1190	DWH04C0	851.67	1022.00
1400	1330-1390	DWH04DH	984.17	1181.00
1700	1630-1690	DWH04EH	1135.83	1363.00

Optional Side Panel				
Size	Adjustment	Code	Price £ Exc. VAT	Price £ Inc. VAT
760	720-750	DWH07B0	404.17	485.00
800	760-790	DWH07D0	400.83	481.00
900	860-890	DWH07E0	472.50	567.00



SCAN FOR MORE INFORMATION



Sliding Door in Recess

## 1 Door Quadrant

The Ionic Essence 1 Door Quadrant offers an optimal showering solution, suitable for smaller bathrooms where a side entry is more practical.

### features

- » Height 1900mm
- » Concealed fixings
- » Space saving solution
- » Chrome finish including top cover caps



1 Door Offset Quadrant / Shown as Right Hand (R)

1 Door Quadrant

#### 1 Door Quadrant

Size	Adjustment	Code	Price £ Exc. VAT	Price £ Inc. VAT
900	850-880	DWH03DH	1178.33	1414.00

#### 1 Door Offset Quadrant

1000 x 800	750-780 / 950-980	DWH03BH	1220.83	1465.00
1200 x 800	750-780 / 1150-1180	DWH03CH	1220.83	1465.00
1200 x 900	850-880 / 1150-1180	DWH03EH	1220.83	1465.00

### Technical drawing

#### 1 Door Quadrant

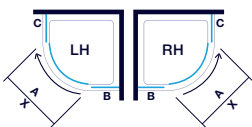

Size	X	B	C
900	450	460	330

X: Door Opening  
A: Moving Panel  
B: Fixed Panel  
C: Fixed Panel

#### 1 Door Offset Quadrant

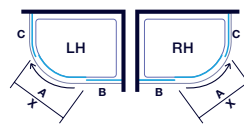

Size	X	B	C
1000 x 800	394	430	430
1200 x 800	394	430	630
1200 x 900	450	460	630

X: Door Opening  
A: Moving Panel  
B: Fixed Panel  
C: Curved Fixed Panel

8<sup>MM</sup>  
GLASS  
THICKNESS

20 YEARS  
GUARANTEE

MERSHIELD<sup>®</sup>  
STAYCLEAR

## 2 Door Quadrant

The Ionic Essence Framed 2 Door Quadrant is an excellent choice for maximizing corner space utilisation, featuring two smooth sliding doors.

### features

- » Height 1900mm
- » Concealed fixings
- » Space saving solution
- » Chrome finish including top cover caps
- » Reversible



2 Door Quadrant

### 2 Door Quadrant

Size	Adjustment	Code	Price £ Exc. VAT	Price £ Inc. VAT
800	750-780	DWH02A0	1085.00	1302.00
900	850-880	DWH02B0	1085.00	1302.00
1000	950-980	DWH02CH	1206.67	1448.00

### Technical drawing

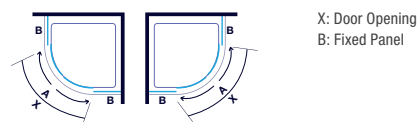

Size	X	B
800	370	180
900	520	280
1000	520	380



## Bifold Door

Incorporating both style and functionality, the Ionic Essence Framed Bifold Door maximizes the usable space. It serves as an ideal solution for bathrooms of all sizes.

### features

- » Height 1900mm
- » Concealed fixings
- » Space saving solution
- » Chrome finish including top cover caps
- » Reversible

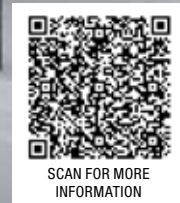

Bifold Door with Side Panel / Shown as Right Hand (R)



Bifold Door in Recess

### Bifold Door

Size	Adjustment	Code	Price £ Exc. VAT	Price £ Inc. VAT
760	690-750	DWH00B0	832.50	999.00
800	730-790	DWH00C0	832.50	999.00
900	830-890	DWH00D0	870.83	1045.00
1000	930-990	DWH00E0	1019.17	1223.00

### Optional Side Panel

Size	Adjustment	Code	Price £ Exc. VAT	Price £ Inc. VAT
760	720-750	DWH07B0	404.17	485.00
800	760-790	DWH07D0	400.83	481.00
900	860-890	DWH07E0	472.50	567.00

### Technical drawing

Bifold Door in Recess

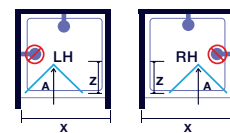

Bifold Door with Side Panel

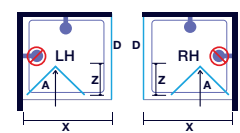

- A: Moving Panel
- D: Side Panel
- X: Door Opening
- Z: Width of panel when folded

Extension profiles available. See page 153.

Size	X	Z
760	436	335
800	476	355
900	576	405
1000	626	455



## Pivot Door

Whether used in conjunction with a side panel or set in a recess, the Ionic Essence Framed Pivot Door offers an elegant yet practical showering solution.

### features

- » Height 1900mm
- » Concealed fixings
- » Chrome finish including top cover caps
- » Reversible
- » Coloured matching chrome magnetic seals
- » Solid "Clunk" close

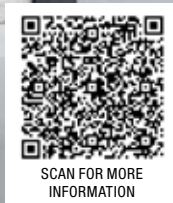

SCAN FOR MORE INFORMATION

Pivot Door with Side Panel / Shown as Right Hand (R)



Pivot Door in Recess

### Pivot Door

Size	Adjustment	Code	Price £ Exc. VAT	Price £ Inc. VAT
760	690-750	DWH06B0	722.50	867.00
800	730-790	DWH06D0	759.17	911.00
900	830-890	DWH06E0	787.50	945.00

### Optional Side Panel

Size	Adjustment	Code	Price £ Exc. VAT	Price £ Inc. VAT
760	720-750	DWH07B0	404.17	485.00
800	760-790	DWH07D0	400.83	481.00
900	860-890	DWH07E0	472.50	567.00

### Technical drawing

Pivot Door in Recess

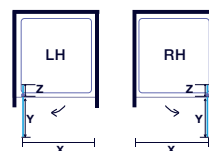

Pivot Door with Side Panel

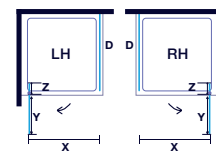

D: Side Panel  
 Y: Outside Door Swing  
 X: Door Opening  
 Z: Inside Door Swing

Size	X	Y	Z
760	433	415	180
800	473	455	180
900	573	555	180



6<sup>MM</sup>  
GLASS  
THICKNESS

20 YEARS  
GUARANTEE

MERSHIELD™  
STAYCLEAR

# IONIC | Express

## Easy-fit system

Express by name, express by nature. With an innovative easy-fit system, the Ionic Express range has been designed with you in mind.

### EASY-FIT STEPS



Step one: Slot & connect frame in place.



Step two: Slide mechanism to secure profile at each corner.

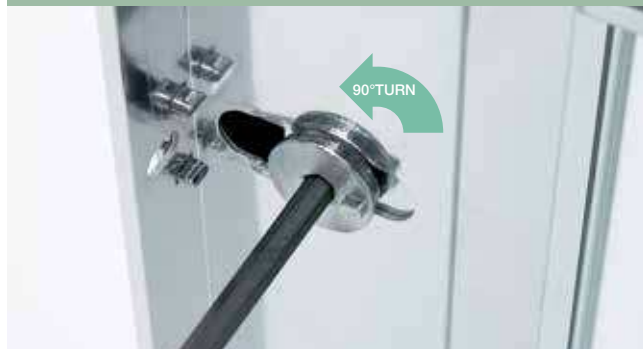

Step three: Quarter turn to lock wall & upright profiles in place, without the need for drilling through aluminium.





Sliding Door with Side Panel / Shown as Left Hand (L)

Technical drawing

Sliding Door in Recess

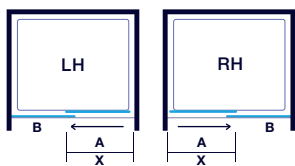

Sliding Door with Side Panel

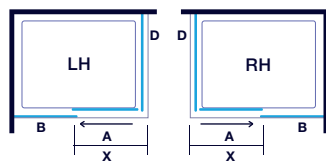

- A: Moving Panel
- B: Fixed Panel
- D: Side Panel
- X: Door Opening

Size	X	B
1000	380	433
1100	430	483
1200	480	533
1400	580	633
1500	580	733
1600	580	833
1700	580	933



## Sliding Door

Offering a range of sizes from 1000mm to 1700mm, the easy to fit Ionic Express Sliding Door provides you with the flexibility to create an ideal showering area for your bathroom.

### features

- » Height 1900mm
- » Easy-fit system
- » Reversible
- » Smooth action extra strong rollers
- » Concealed fixing
- » Easy clean quick release rollers
- » Double fin seal for increased water retention
- » Rollers pre-assembled on door

#### Sliding Door

Size	Adjustment	Code	Price £ Exc. VAT	Price £ Inc. VAT
1000	950-990	A0304A0	695.00	834.00
1100	1050-1090	A0304B0	695.00	834.00
1200	1150-1190	A0304C0	689.17	827.00
1400	1350-1390	A0304DH	885.83	1063.00
1500	1450-1490	A0304GH	943.33	1132.00
1600	1550-1590	A0304EH	965.00	1158.00
1700	1650-1690	A0304HH	976.67	1172.00

#### Optional Side Panel

Size	Adjustment	Code	Price £ Exc. VAT	Price £ Inc. VAT
700	650-670	A0307A0	432.50	519.00
760	710-730	A0307B0	428.33	514.00
800	750-770	A0307D0	428.33	514.00
900	850-870	A0307E0	472.50	567.00

#### Optional Inline Panel

Size	Adjustment	Code	Price £ Exc. VAT	Price £ Inc. VAT
150	130-150	A0315B0	370.00	444.00
210	190-210	A0315C0	360.00	432.00
490 (New)	470-490	A0315D0	432.50	519.00

For Inline Panel size calculations please see page 156.  
Please Note: Sliding Door can be paired with 2 additional Side Panels.



SCAN FOR MORE INFORMATION



Sliding Door in Recess



Sliding Door with Side Panel / Shown as Left Hand (L)

Technical drawing

Sliding Door in Recess

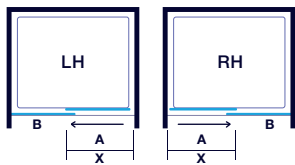

Sliding Door with Side Panel

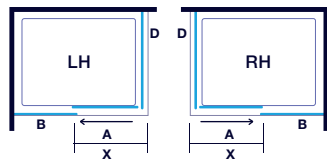

- A: Moving Panel
- B: Fixed Panel
- D: Side Panel
- X: Door Opening

Size	X	B
1000	376	433
1200	476	533
1400	576	633
1700	576	933

## Sliding Door Low Level Access

Create a fully inclusive bathroom environment with the low level access sliding door, thanks to its minimal bottom rail. Available in the same sizes as the standard Ionic Express Sliding Door.

### features

- » Height 1900mm
- » Easy-fit system
- » Door Handed
- » No bottom rollers - bottom glide system instead
- » Push-button door release for easy clean
- » Rollers pre-assembled on the top of the door
- » Allows easy access for users on both tray and wetroom situations - no more stepping required.
- » Adjustable fin seal for increased water retention, allowing the seal to always be flush with the floor/ tray

#### Sliding Door

Size	Adjustment in Recess	Adjustment with Side Panel	Code	Price £ Exc. VAT	Price £ Inc. VAT
1000	950-990	960-1000	A0303A0 <b>L</b>	792.50	951.00
1000	950-990	960-1000	A0303B0 <b>R</b>	792.50	951.00
1200	1150-1190	1160-1200	A0303G0 <b>L</b>	829.17	995.00
1200	1150-1190	1160-1200	A0303H0 <b>R</b>	829.17	995.00
1400	1350-1390	1360-1400	A0303LH <b>L</b>	1019.17	1223.00
1400	1350-1390	1360-1400	A0303MH <b>R</b>	1019.17	1223.00
1700	1650-1690	1660-1700	A0303SH <b>L</b>	1124.17	1349.00
1700	1650-1690	1660-1700	A0303TH <b>R</b>	1124.17	1349.00

#### Optional Side Panel

Size	Adjustment	Code	Price £ Exc. VAT	Price £ Inc. VAT
700	650-670	A0307A0	432.50	519.00
760	710-730	A0307B0	428.33	514.00
800	750-770	A0307D0	428.33	514.00
900	850-870	A0307E0	472.50	567.00

#### Optional Inline Panel

Size	Adjustment	Code	Price £ Exc. VAT	Price £ Inc. VAT
150	130-150	A0315B0	370.00	444.00
210	190-210	A0315C0	360.00	432.00
490	470-490	A0315D0	432.50	519.00



SCAN FOR MORE INFORMATION



Sliding Door in Recess



6<sup>MM</sup>  
GLASS  
THICKNESS

20 YEARS  
GUARANTEE

MERSHIELD<sup>®</sup>  
STAYCLEAR

## 1 Door Quadrant

The Ionic Express 1 Door Quadrant offers an efficient space-saving solution for your bathroom. It features quick release rollers for ease of cleaning.

### features

- » Height 1900mm
- » Easy-fit system
- » Reversible
- » Concealed fixing
- » Smooth action extra strong rollers
- » Double fin seal for increased water retention
- » Easy clean quick release rollers
- » Rollers pre-assembled on door

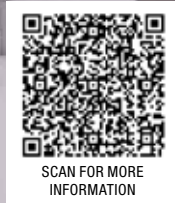

1 Door Quadrant / Shown as Left Hand (L)

### 1 Door Quadrant

Size	Adjustment	Code	Price £ Exc. VAT	Price £ Inc. VAT
900	855-875	A0301B0	1000.83	1201.00

### Technical drawing

#### 1 Door Quadrant

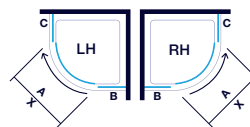

A: Moving Panel  
B: Fixed Panel  
C: Fixed Panel  
X: Door Opening

Size	X	B	C
900	460	526	321

6<sup>MM</sup>  
GLASS  
THICKNESS

20 YEARS  
GUARANTEE

MERSHIELD<sup>®</sup>  
STAYCLEAR

## 2 Door Quadrant

The Ionic Express 2 Door Quadrant is designed with two sliding doors that glide smoothly, offering convenient access to the shower space.

### features

- » Height 1900mm
- » Easy-fit system
- » Reversible
- » Concealed fixing
- » Smooth action extra strong rollers
- » Double fin seal for increased water retention
- » Easy clean quick release rollers
- » Rollers pre-assembled on door tray



2 Door Offset Quadrant



2 Door Quadrant

### 2 Door Quadrant

Size	Adjustment	Code	Price £ Exc. VAT	Price £ Inc. VAT
800	755-775	A0302A0	802.50	963.00
900	855-875	A0302B0	795.00	954.00

20mm Adjustment per wall profile.

### 2 Door Offset Quadrant

Size	Adjustment	Code	Price £ Exc. VAT	Price £ Inc. VAT
900 x 760	855-875 / 715-735	A0302C0	919.17	1103.00
1000 x 800	955-975 / 755-775	A0302D0	974.17	1169.00
1200 x 800	1155-1175 / 755-775	A0302HH	1119.17	1343.00
1200 x 900	1155-1175 / 855-875	A0302IH	1154.17	1385.00

### Technical drawing

#### 2 Door Quadrant

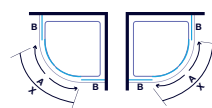

A: Moving Panel  
B: Fixed Panel  
X: Door Opening

Size	X	B
800	390	221
900	540	321

#### 2 Door Offset Quadrant

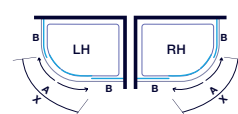

A: Moving Panel  
B: Fixed Panel  
X: Door Opening

Size	X	B	C
900 x 760	430	321	181
1000 x 800	465	421	221
1200 x 800	465	621	221
1200 x 900	540	621	321

## Bifold Door

The Ionic Express Bifold Door is the perfect solution for smaller bathrooms with limited space. The inward opening makes it easier to access the shower.

### features

- » Height 1900mm
- » Easy-fit system
- » Reversible
- » Concealed fixings
- » Discreet chrome bifold hinge
- » 20mm adjustment per wall profile



Bifold Door with Side Panel & Inline Panel / Shown as Left Hand (L)



Bifold Door Shown in Recess

### Bifold Door

Size	Adjustment	Code	Price £ Exc. VAT	Price £ Inc. VAT
760	710-750	A0300B0	665.83	799.00
800	750-790	A0300C0	671.67	806.00
900	850-890	A0300D0	710.83	853.00
1000	950-990	A0300E0	826.67	992.00

### Optional Side Panel

Size	Adjustment	Code	Price £ Exc. VAT	Price £ Inc. VAT
700	650-670	A0307A0	432.50	519.00
760	710-730	A0307B0	428.33	514.00
800	750-770	A0307D0	428.33	514.00
900	850-870	A0307E0	472.50	567.00

### Optional Inline Panel

Size	Adjustment	Code	Price £ Exc. VAT	Price £ Inc. VAT
150	130-150	A0315B0	370.00	444.00
210	190-210	A0315C0	360.00	432.00
490 (New)	470-490	A0315D0	432.50	519.00

For Inline Panel size calculations please see page 156.

### Technical drawing

Bifold Door in Recess

Bifold Door with Side Panel

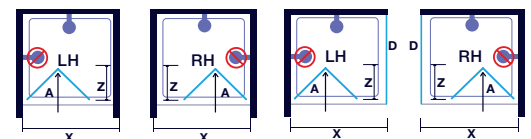

A: Moving Panel  
Z: Width of panel when folded  
X: Door Opening

Extension profiles available. See page 153.

Size	X	Z
760	475	315
800	515	355
900	615	405
1000	665	455

## Pivot Door

The outward opening of the Ionic Express Pivot Door offers an efficient and versatile solution. It can be installed in a recess or combined with a side panel, with the option to add an inline panel.

### features

- » Height 1900mm
- » Easy-fit system
- » Reversible
- » Concealed fixings
- » 20mm adjustment per wall profile

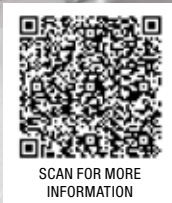

SCAN FOR MORE  
INFORMATION

Pivot Door Shown with Side Panel & Inline Panel / Shown as Left Hand (L)



Pivot Door Shown in Recess

### Pivot Door

Size	Adjustment	Code	Price £ Exc. VAT	Price £ Inc. VAT
700	650-690	A0306A0	610.00	732.00
760	710-750	A0306B0	594.17	713.00
800	750-790	A0306D0	599.17	719.00
900	850-890	A0306E0	683.33	820.00
1000	950-990	A0306G0	774.17	929.00

### Optional Side Panel

Size	Adjustment	Code	Price £ Exc. VAT	Price £ Inc. VAT
700	650-670	A0307A0	432.50	519.00
760	710-730	A0307B0	428.33	514.00
800	750-770	A0307D0	428.33	514.00
900	850-870	A0307E0	472.50	567.00

### Optional Inline Panel

Size	Adjustment	Code	Price £ Exc. VAT	Price £ Inc. VAT
150	130-150	A0315B0	370.00	444.00
210	190-210	A0315C0	360.00	432.00
490 (new)	470-490	A0315D0	432.50	519.00

For Inline Panel size calculations please see page 156.

### Technical drawing

#### Pivot Door in Recess

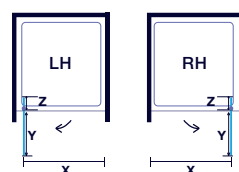

#### Pivot Door with Side Panel

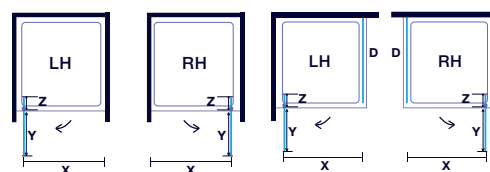

D: Side Panel  
Y: Outside Door Swing  
Z: Inside Door Swing  
X: Door Opening

Extension profiles available.  
See page 153.

Size	X	Y	Z
700	415	390	175
760	475	450	175
800	515	490	175
900	615	590	175
1000	715	690	175





6<sup>MM</sup>  
GLASS  
THICKNESS

5 YEARS  
GUARANTEE

# IONIC | Source

## Exceptional quality

Ionic Source is our exciting range of affordable 6mm shower enclosures. This range has been developed to offer our customers an exceptional quality shower enclosure at an affordable price.

### EASY-FIT STEPS

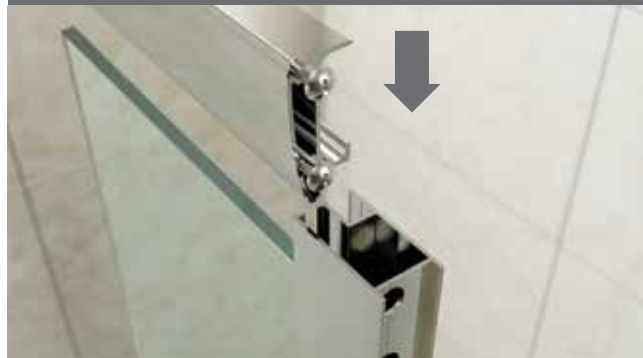

Step one: Align the horizontal and vertical profiles together.



Step two: Slot the horizontal profile and screws into upright using guide channel until flush.



Step three: Secure screws into position using dedicated access holes.



*Sliding Door with Side Panel / Shown as Left Hand (L)*

*Technical drawing*

Sliding Door in Recess



Sliding Door with Side Panel

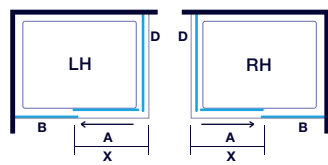

Size	X	B
1000	380	400
1100	430	450
1200	480	500

- A: Moving Panel
- B: Fixed Panel
- D: Side Panel
- X: Door Opening

6<sup>MM</sup>  
GLASS  
THICKNESS

5 YEARS  
GUARANTEE

## Sliding Door

The Ionic Sliding Door is an ideal choice for those seeking a contemporary and affordable shower enclosure

### features

- » Height 1850mm
- » Reversible
- » Easy fit frame
- » Screw cover caps
- » Magnetic seals
- » Chrome quick release easy clean bottom rollers

Sliding Door				
Size	Adjustment	Code	Price £ Exc. VAT	Price £ Inc. VAT
1000	950-990	A1204A0	396.67	476.00
1100	1050-1090	A1204B0	396.67	476.00
1200	1150-1190	A1204C0	405.00	486.00

20mm Adjustment per wall profile.

Optional Side Panel				
Size	Adjustment	Code	Price £ Exc. VAT	Price £ Inc. VAT
760	730-750	A1207B0	237.50	285.00
800	770-790	A1207D0	235.00	282.00
900	870-890	A1207E0	253.33	304.00



SCAN FOR MORE  
INFORMATION



Sliding Door in Recess



## 2 Door Quadrant

Created with affordability in mind, the Ionic Source 2 Door Quadrant offers ample showering space.

### features

- » Height 1850mm
- » Reversible
- » Easy fit frame
- » Fixing cover caps
- » Magnetic seals
- » Chrome quick release easy clean bottom rollers

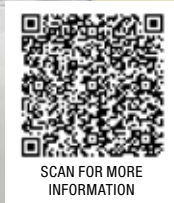

2 Door Offset Quadrant



2 Door Quadrant

### 2 Door Quadrant

Size	Adjustment	Code	Price £ Exc. VAT	Price £ Inc. VAT
800	770-790	A1202A0	396.67	476.00
900	870-890	A1202B0	393.33	472.00

### 2 Door Offset Quadrant

Size	Adjustment	Code	Price £ Exc. VAT	Price £ Inc. VAT
1000 x 800	970-990 / 770-790	A1202D0	550.00	660.00
1200 x 800	1170-1190 / 770-790	A1202HH	545.83	655.00
1200 x 900	1170-1190 / 870-890	A1202IH	560.83	673.00

### Technical drawing

#### 2 Door Quadrant

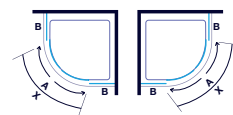

A: Moving Panel  
B: Fixed Panel  
C: Fixed Panels  
X: Door Opening

Size	X	B	C
800	400	210	210
900	540	310	310
1000 x 800	470	410	210
1200 x 800	470	610	210
1200 x 900	540	610	310

#### 2 Door Offset Quadrant

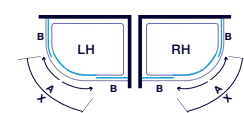

A: Moving Panel  
B: Fixed Panel  
C: Fixed Panels  
X: Door Opening

6<sup>MM</sup>  
GLASS  
THICKNESS

5 YEARS  
GUARANTEE

## Pivot Door

The Ionic Source Pivot Door offers an easy showering experience and a clean, tidy look.

### features

- » Height 1850mm
- » Reversible
- » Minimalist pivot
- » Pre-assembled frame
- » Screw cover caps
- » Magnetic seals



Pivot Door with Side Panel / Shown as Right Hand (R)



Pivot Door

#### Pivot Door

Size	Adjustment	Code	Price £ Exc. VAT	Price £ Inc. VAT
760	710-750	A1206B0	314.17	377.00
800	750-790	A1206D0	345.83	415.00
900	850-890	A1206E0	380.83	457.00

20mm Adjustment per wall profile.

#### Optional Side Panel

Size	Adjustment	Code	Price £ Exc. VAT	Price £ Inc. VAT
760	730-750	A1207B0	237.50	285.00
800	770-790	A1207D0	235.00	282.00
900	870-890	A1207E0	253.33	304.00

### Technical drawing

Pivot Door Recess

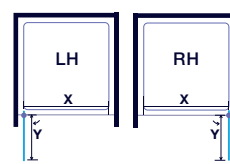

Pivot Door with Side Panel

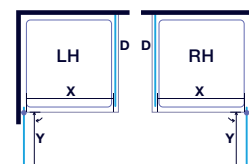

X: Door Opening  
Y: Outside Door Swing

Extension profiles available. See page 153.

Size	X	Y
760	490	460
800	530	500
900	630	600

## Bifold Door

The inward opening of the Ionic Source Bifold Door offers a simple and practical solution for saving space.

### features

- » Height 1850mm
- » Reversible
- » Pre-assembled frame
- » Screw cover caps
- » Smooth running action
- » Magnetic seals

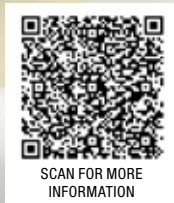

*Bifold Door with Side Panel / Shown as Left Hand (L)*



*Bifold Door in Recess*

### Bifold Door

Size	Adjustment	Code	Price £ Exc. VAT	Price £ Inc. VAT
700	650-690	A1200A0	387.50	465.00
760	710-750	A1200B0	380.83	457.00
800	750-790	A1200C0	396.67	476.00
900	850-890	A1200D0	408.33	490.00

20mm Adjustment per wall profile.

### Optional Side Panel

Size	Adjustment	Code	Price £ Exc. VAT	Price £ Inc. VAT
760	730-750	A1207B0	237.50	285.00
800	770-790	A1207D0	235.00	282.00
900	870-890	A1207E0	253.33	304.00

### Technical drawing

Bifold Door in Recess

Bifold Door with Side Panel

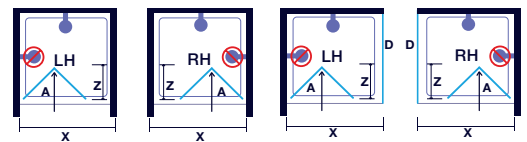

A: Moving Panel

Z: Width of panel when folded

X: Door Opening

Extension profiles available. See page 153.

Size	X	Z
700	400	280
760	460	310
800	500	330
900	600	380

6<sup>MM</sup>  
GLASS  
THICKNESS

5 YEARS  
GUARANTEE

## Corner Door

The Ionic Source Corner Door has sliding doors on both sides, offering quality and practicality in a simple design.

### features

- » Height 1850mm
- » Reversible
- » Easy fit frame
- » Screw cover caps
- » Chrome quick release easy clean bottom rollers
- » Magnetic seals



Corner Door with Side Panel



Adjustment profile close up

### Corner Door

Size	Adjustment	Code	Price £ Exc. VAT	Price £ Inc. VAT
760/800	740-790	A1212V0	540.00	648.00
900	870 -890	A1212B0	565.83	679.00

20mm Adjustment per wall profile.

### Technical drawing

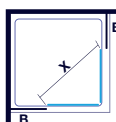

Size	X	B
760/800	350-390	300
900	460	350

X: Door Opening  
B: Fixed Panels

Extension profiles available. See page 153.





6<sup>MM</sup>  
GLASS  
THICKNESS

10 YEARS  
GUARANTEE

MERSHIELD™  
STAYCLEAR

MERLYN™ | 

## THE EASIEST DOOR TO FIT

The innovative MERLYN IQ range takes the hassle out of fitting. The unique patented easy-fit mechanism makes fitting MERLYN IQ simple and easy to install. Slider, Quadrants and Corner doors are under British Patent No. 2,580,730

### ONE PERSON FIT



Slot & lock system  
- no screws



No drilling on frame



Click on rollers



Assembled on tray



Watch our  
fitting video  
here



Sliding Door with Side Panel / Shown as Right Hand (R)

Technical drawing

Sliding Door in Recess



Sliding Door with Side Panel

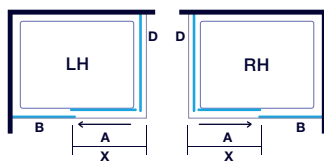

A: Moving Panel  
 B: Fixed Panel  
 D: Side Panel  
 X: Door Opening

Extension profiles available. See page 153.

Size	X	B
1000	375	435
1100	425	485
1200	475	535
1400	575	635
1500	575	735
1600	575	835
1700	575	935

6  
MM  
GLASS  
THICKNESS

10 YEARS  
GUARANTEE

MERSHIELD™  
STAYCLEAR

## Sliding Door

With its easy clean features, the IQ Sliding Door offers a practical and economical solution.

### features

- » Height 1900mm
- » 6mm Toughened Safety Glass
- » Easy Clean Frame
- » Reversible
- » Mershield™ Easy Clean Glass
- » Chrome Designer Handle
- » 10 Year Guarantee



Slot



Secure



Click on Rollers

### Sliding Door

Size	Adjustment in Recess	Adjustment with Side Panel	Code	Price £ Exc. VAT	Price £ Inc. VAT
1000	950-990	960-1000	KAS10	613.33	736.00
1100	1050-1090	1060-1100	KAS11	613.33	736.00
1200	1150-1190	1160-1200	KAS12	596.67	716.00
1400	1350-1390	1360-1400	KAS14	688.33	826.00
1500	1450-1490	1460-1500	KAS15	710.00	852.00
1600	1550-1590	1560-1600	KAS16	725.00	870.00
1700	1650-1690	1660-1700	KAS17	750.00	900.00

### Optional Side Panel

Size	Adjustment	Code	Price £ Exc. VAT	Price £ Inc. VAT
700	670-690	KASP70	322.50	387.00
760	730-750	KASP76	319.17	383.00
800	770-790	KASP80	313.33	376.00
900	870-890	KASP90	339.17	407.00
1000	970-990	KASP10	435.00	522.00



SCAN FOR MORE  
INFORMATION



Sliding Door in Recess



6<sup>MM</sup>  
GLASS  
THICKNESS

10 YEARS  
GUARANTEE

MERSHIELD™  
STAYCLEAR

## 1 Door Quadrant

The IQ 1 Door Quadrant is engineered for easy installation and efficient use of bathroom space.

### features

- » Height 1900mm
- » 6mm Toughened Safety Glass
- » Easy Clean Frame
- » Reversible
- » Mershield™ Easy Clean Glass
- » Chrome Designer Handle
- » 10 Year Guarantee



Slot



Secure



Click on Rollers

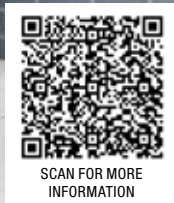

1 Door Quadrant / Shown as Right Hand (R)



1 Door Offset Quadrant

### 1 Door Quadrant

Size	Adjustment	Code	Price £ Exc. VAT	Price £ Inc. VAT
800 x 800	770-790	KA1Q80	790.83	949.00
900 x 900	870-890	KA1Q90	784.17	941.00
1000 x 1000	970-990	KA1Q100	936.67	1124.00

### 1 Door Offset Quadrant

Size	Adjustment	Code	Price £ Exc. VAT	Price £ Inc. VAT
1000 x 800	970-990 / 770-790	KA1Q108	920.83	1105.00
1200 x 800	1170-1190 / 770-790	KA1Q128	910.83	1093.00
1200 x 900	1170-1190 / 870-890	KA1Q129	950.83	1141.00

### Technical drawing

#### 1 Door Quadrant

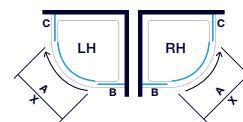

A: Moving Panel  
B: Fixed Panel  
C: Fixed Panel  
X: Door Opening

Size	X	B	C
800 x 800	435	490	215
900 x 900	485	530	325
1000 x 1000	485	630	425
1000 x 800	435	490	425
1200 x 800	435	490	625
1200 x 900	485	530	625

#### 1 Door Offset Quadrant

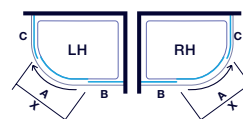

A: Moving Panel  
B: Fixed Panel  
C: Curved Fixed Panel  
X: Door Opening



## 2 Door Quadrant

With two sliding doors, the IQ 2 Door Quadrant is ideal as a space-saving shower enclosure.

### features

- » Height 1900mm
- » 6mm Toughened Safety Glass
- » Easy Clean Frame
- » Reversible
- » Mershield™ Easy Clean Glass
- » Chrome Designer Handle
- » 10 Year Guarantee



Slot



Secure



Click on Rollers



SCAN FOR MORE INFORMATION

2 Door Quadrant



2 Door Offset Quadrant

### 2 Door Quadrant

Size	Adjustment	Code	Price £ Exc. VAT	Price £ Inc. VAT
800 x 800	770-790	KA2Q80	580.83	697.00
900 x 900	870-890	KA2Q90	575.83	691.00

### 2 Door Offset Quadrant

Size	Adjustment	Code	Price £ Exc. VAT	Price £ Inc. VAT
900 x 760	870-890 / 730-750	KA2Q976	655.00	786.00
900 x 800	870-890 / 770-790	KA2Q980	694.17	833.00
1000 x 800	970-990 / 770-790	KA2Q108	704.17	845.00
1200 x 800	1170-1190 / 770-790	KA2Q128	710.00	852.00
1200 x 900	1170-1190 / 870-890	KA2Q129	740.83	889.00

### Technical drawing

#### 2 Door Quadrant

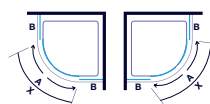

A: Moving Panel  
 B: Fixed Panel  
 X: Door Opening

Size	X	B	C
800 x 800	385	225	225
900 x 900	545	325	325
900 x 760	435	325	185
900 x 800	470	325	225
1000 x 800	470	425	225
1200 x 800	470	625	225
1200 x 900	545	625	325

#### 2 Door Offset Quadrant

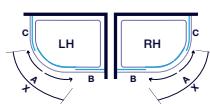

A: Moving Panel  
 B: Fixed Panel  
 C: Curved Fixed Panel  
 X: Door Opening



## Bifold Door

The IQ Bifold door is a great option for small bathrooms with limited space.

### features

- » Height 1900mm
- » 6mm Toughened Safety Glass
- » Easy Clean Frame
- » Reversible
- » Mershield™ Easy
- Clean Glass
- » Chrome Designer Handle
- » 10 Year Guarantee



Frame Locking System

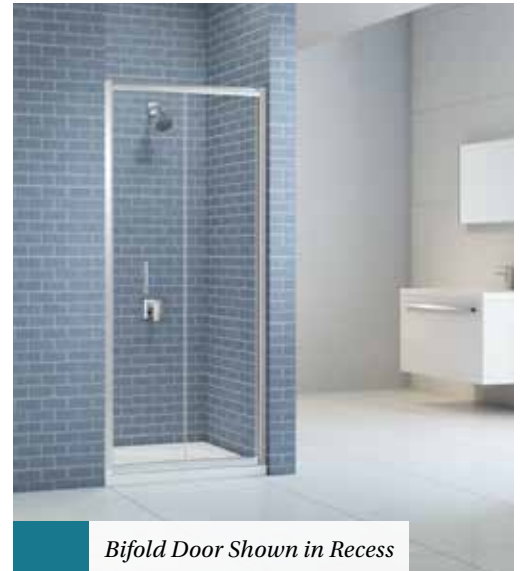

Bifold Door Shown in Recess

Bifold Door with Side Panel / Shown as Right Hand (R)

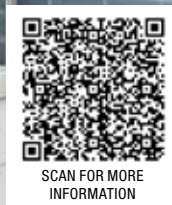

SCAN FOR MORE INFORMATION

### Bifold Door

Size	Adjustment in Recess	Adjustment with Side Panel	Code	Price £ Exc. VAT	Price £ Inc. VAT
700	650-690	655-675	KAB70	565.00	678.00
760	710-750	715-735	KAB76	560.00	672.00
800	750-790	755-775	KAB80	565.00	678.00
900	850-890	855-875	KAB90	591.67	710.00
1000	950-990	955-975	KAB10	640.00	768.00

### Optional Side Panel

Size	Code	Price £ Exc. VAT	Price £ Inc. VAT	
700	662-682	KASP70	322.50	387.00
760	722-742	KASP76	319.17	383.00
800	762-782	KASP80	313.33	376.00
900	862-882	KASP90	339.17	407.00
1000	962-982	KASP10	435.00	522.00

### Technical drawing

Bifold Door in Recess

Bifold Door with Side Panel

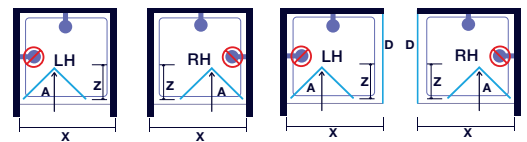

A: Moving Panel

Z: Width of panel when folded

X: Door Opening

Extension profiles available. See page 153.

Size	X	Z
700	415	300
760	460	330
800	490	350
900	570	400
1000	650	450





## Pivot Door

The IQ Pivot Door provides a practical solution for easy showering and a clean, uncluttered appearance.

### features

- » Height 1900mm
- » 6mm Toughened Safety Glass
- » Easy Clean Frame
- » Reversible
- » Mershield™ Easy Clean Glass
- » Chrome Designer Handle
- » 10 Year Guarantee



Frame Locking System



Pivot Door Shown in Recess



SCAN FOR MORE INFORMATION

Pivot Door Shown with Side Panel / Shown as Left Hand (L)

### Pivot Door

Size	Adjustment in Recess	Adjustment with Side Panel	Code	Price £ Exc. VAT	Price £ Inc. VAT
700	650-690	655-675	KAP70	484.17	581.00
760	710-750	715-735	KAP76	505.00	606.00
800	750-790	755-775	KAP80	505.00	606.00
900	850-890	855-875	KAP90	537.50	645.00
1000	950-990	955-975	KAP10	569.17	683.00

### Optional Side Panel

Size	Adjustment	Code	Price £ Exc. VAT	Price £ Inc. VAT
700	662-682	KASP70	322.50	387.00
760	722-742	KASP76	319.17	383.00
800	762-782	KASP80	313.33	376.00
900	862-882	KASP90	339.17	407.00
1000	962-982	KASP10	435.00	522.00

### Technical drawing

Pivot Door Recess



Pivot Door with Side Panel

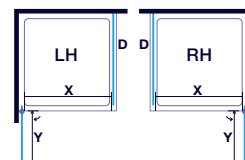

D: Side Panel  
X: Door Opening  
Y: Outside Door Swing

Extension profiles available. See page 153.

Size	X	Y
700	455	460
760	515	525
800	535	540
900	610	605
1000	660	655







10<sup>MM</sup>  
GLASS  
THICKNESS

LIFETIME  
GUARANTEE

MERSHIELD<sup>™</sup>  
STAYCLEAR

# MERLYN<sup>™</sup> | Wetrooms

Solution for every situation

Wetrooms are a modern and elegant option for your bathroom. With MERLYN Wetrooms, you can enjoy the best of both worlds: versatility and luxury. A MERLYN wetroom can transform the bathroom to a more clean and luxurious space.

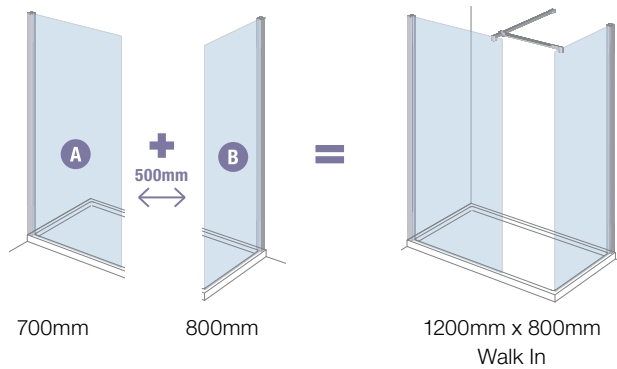

**How it works:** To make up a walk In wetroom to fit on a 1200mm x 800mm tray or area floor space. You pick panel A (700mm) and panel B (800mm), this also includes the recommended 500mm minimum opening for the Walk In.



*Wetroom Panel / with Swivel Panel (E)*

*Fitting Options*



**A**  
Angled Bracing Bar -  
Chrome Only



**B**  
Stabilising Bracing Bar -  
Colour options



**C**  
Ceiling Bracing Bar -  
Chrome Only



**H**  
U Channel



**I**  
Flush Wall Profile

## 10 Series Wetroom Panels

Luxurious Wetroom Panels, crafted with our signature 10mm glass. Each Wetroom panel comes with a wall profile you can tailor with various options. Pick and choose from the 9 additional options to give your wetroom the luxurious finish.

### features

- » Height 2000mm
- » Height including rail is 2015mm
- » 10mm toughened glass
- » Choice of additional options to tailor your wetroom to suit your space
- » Suitable for a recess or corner situation
- » Suitable for wetroom and shower tray application
- » Lifetime Guarantee
- » Reversible

Wetroom Panels (including wall profile only)					Wetroom Panels with Straight Stabilising Bar (including Wall Profile)			
Size	Adjustment	Code	Price £ Exc. VAT	Price £ Inc. VAT	Additional Option	Code	Price £ Exc. VAT	Price £ Inc. VAT
300**	275-290	S10SW300H	350.00	420.00	A	S10SW300H	500.00	600.00
400**	375-390	S10SW400H	358.33	430.00	A	S10SW400H	508.33	610.00
500**	475-490	S10SW500H	366.67	440.00	A	S10SW500H	516.67	620.00
600**	575-590	S10SW600H	379.17	455.00	A	S10SW600H	529.17	635.00
700**	675-690	S10SW700H	383.33	460.00	A	S10SW700H	533.33	640.00
800**	775-790	S10SW800H	391.67	470.00	A	S10SW800H	541.67	650.00
900**	875-890	S10SW900H	400.00	480.00	A	S10SW900H	550.00	660.00
1000	975-990	S10SW1000H	408.33	490.00	A	S10SW1000H	558.33	670.00
1100	1075-1090	S10SW1100H	416.67	500.00	A	S10SW1100H	566.67	680.00
1200	1175-1190	S10SW1200H	433.33	520.00	A	S10SW1200H	583.33	700.00
1400	1375-1390	S10SW1400H	458.33	550.00	A	S10SW1400H	608.33	730.00

\*\*Please Note: These sizes are the only sizes we recommend for use as end panels. We recommend a minimum opening space of 500mm.

### Additional Options

Size	Product	Code	Price £ Exc. VAT	Price £ Inc. VAT
A 350	Angled Stabilising Bar	SP08SCU12320	95.83	115.00
B max 1 metre	Straight Stabilising Bar*	SP0S8TRSET N	150.00	180.00
C 400	Vertical Ceiling Bracing Bar***	CBB440	115.00	138.00
D N/A	T Bracket (to connect 2 stabilising bars)	SP0S8RTPSET	50.00	60.00
E 300	Swivel Panel 8mm glass	M8SWS30 N	220.83	265.00
G max 3 metres	Vertical Post	A0417C0 N	133.33	160.00
H max 1400	U channel	MGVC35A	40.83	49.00
I -	Flush Wall Profile†	SP02000FWP		
J -	Flush Floor Profile†	SP01400FFP		

\*Please Note: We recommend the use of a stabilising bar for any wetroom panel over 900mm.

\*\*\*Please note: Max height of ceiling bar from top of glass is 400mm.

†Please Note: These are available as bespoke options. Please contact Customer Services for sizes and prices.



SCAN FOR MORE  
INFORMATION



J  
Flush Floor Profile



Wetroom



Wetroom / with Vertical Post (G)





*Wetroom Panel / with Swivel Panel (B)*

*Fitting Options*



**A**  
Angled Stabilising Bar



**E**  
Corner Profile



**F**  
Vertical Ceiling Bar



## 8 Series Wetroom Panels

The 8 Series Wetroom Panels are stylish yet functional by design. With frameless 8mm toughened safety glass, these panels stands at an impressive 2015mm high, including rail and are suitable for a recess or a corner situation. They are guaranteed to make a statement in any bathroom.

### features

- » Height 2015mm including rail
- » Suitable for wetroom and shower tray application
- » 1m Square stabilising bar comes as standard with all sizes
- » Suitable for recess or corner situation
- » Cubic profile
- » Reversible

### Wetroom Panels

Size	Adjustment	Code	Price £ Exc. VAT	Price £ Inc. VAT
700	670-690	M8SW201	315.00	378.00
800	770-790	M8SW211	320.83	385.00
900	870-890	M8SW221	325.00	390.00
1000	970-990	M8SW231	354.17	425.00
1200	1170-1190	M8SW241	381.67	458.00

1000mm square stabilising bar comes as standard with all products.

### Additional Options

Size	Product	Code	Price £ Exc. VAT	Price £ Inc. VAT
A 350	Angled Stabilising Bar	SP08SCU12320	95.83	115.00
B 300	Swivel Panel	M8SWS30 N	220.83	265.00
D max 3 metres	Vertical Post	A0417C0 N	133.33	160.00
E 2000	Corner profile-Glass to glass profile	8WCR	62.50	75.00
F 400	Vertical Ceiling Bracing Bar***	CBB440	115.00	138.00

\*Please Note: We recommend the use of a stabilising bar for any Wetroom Panels over 900mm.

\*\*\*Please note: Max height of ceiling bar from top of glass is 400mm.



SCAN FOR MORE INFORMATION



Wetroom Panel / with End Panel (C)



Wetroom Panel / with Vertical Post (D)

## 8 Series Pivot Wetroom

Our 8mm Pivot Wetroom panels offer you the choice of a single wetroom panel, perfect for tight spaces, or a double wetroom panel which creates an enclosed corner situation. Choices to create the space you desire.

### features

- » Height 1950mm
- » Solid chrome double handle
- » Cover caps
- » Space saving solution
- » Inward and outward opening swing
- » Concealed fixings
- » Reversible
- » Wetroom compatible



SCAN FOR MORE INFORMATION

*Double Pivot*



*Double Pivot - Folded Inwards*

### Pivot Wetroom Panels / Single

Size	Adjustment	Code	Price £ Exc. VAT	Price £ Inc. VAT
760	690-710	S8FPV76	815.83	979.00
800	730-750	S8FPV80	839.17	1007.00
900	830-850	S8FPV90	893.33	1072.00
1000	930-950	S8FPV100	924.17	1109.00

Please Note: We recommend fitting this product in a Wetroom situation only.

### Pivot Wetroom Panels / Double

Size	Adjustment	Code	Price £ Exc. VAT	Price £ Inc. VAT
760 x 760	690-710	S8FPC76H	1566.67	1880.00
800 x 800	730-750	S8FPC80H	1721.67	2066.00
900 x 900	830-850	S8FPC90H	1709.17	2051.00
1000 x 1000	930-950	S8FPC100H	1872.50	2247.00

Please Note: We recommend fitting this product in a Wetroom situation only.



*Single Pivot - Folded Inwards*



## 8 Series Curved Wetroom

The Curved Wetroom panel follows the contour of your offset quadrant tray, giving a softer finish. The extra length of the curved panel also deflects water spray inwards. This frameless design boasts Mershield Stayclear™, ensuring peace of mind with the MERLYN Lifetime Guarantee.

### features

- » Height 2015mm including rail
- » Suitable for wetroom and shower tray application
- » Can be used with 800mm or 900mm trays
- » Hinged swivel panel swings inwards only to deflect shower spray
- » Minimalist frameless design
- » Reversible



Curved Wetroom Panel



SCAN FOR MORE INFORMATION



Curved Hinged Wetroom Panel

### Curved Wetroom Panels

Size	Adjustment	Code	Price £ Exc. VAT	Price £ Inc. VAT
900	885-900	S8CURV900	1190.83	1429.00
1000	985-1000	S8CURV1000	1255.83	1507.00
1200	1185-1200	S8CURV1200	1357.50	1629.00

### Curved Wetroom Panel Foot

-	-	S8CSWLEG	116.34	139.60
---	---	----------	--------	--------

This foot allows for greater stability on quadrant trays and sloped wetroom floors.

### Curved Hinged Wetroom Panels

Size	Front Panel	Hinged Panel	Code	Price £ Exc. VAT	Price £ Inc. VAT
1000	700	300	M8SWC700	1029.17	1235.00
1200	900	300	M8SWC900	1092.50	1311.00

### Technical drawing

Panel Size	Tray Size	A	B	C
900	900 x 900	810	275	600
1000	1000 x 800	910	275	500
1200	1200 x 800	1110	275	500
	1200 x 900	1110	275	600

Wetroom application

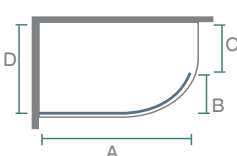

Tray application

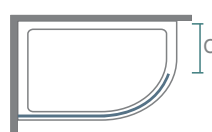

Curved Hinged Wetroom Panel

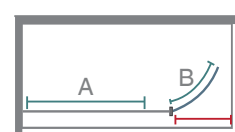

Minimum opening recommended 500mm.

We recommend a minimum opening of 500mm.

A = Panel length

B = Panel depth

C = Panel opening

D = Distance from the wall to the outside of the frame should be max 970mm. This is to allow the stabilising bar to reach the wall.

A = Front Panel B = Hinged Panel

700 300

900 300



## 8 Series Hinged Swivel

Our hinged swivel panel features two beautifully crafted designer hinges that give this door a stunning frameless and minimalist finish. The stylish yet understated model is flexible in terms of options and is available with or without an end panel.

### features

- » Height 2015mm including rail
- » Swivel panel can be adjusted to deflect shower spray. Inward only opening swing
- » Reversible
- » Minimalist frameless design
- » Suitable for wetroom and shower tray application

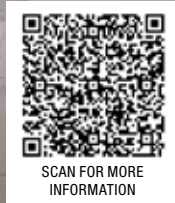

### Wetroom Panels with Hinged Swivel Panel

Walk In with Hinged Swivel Panel					
Area	Panel Size (Front+Swivel+End Panel)	Opening	Code	Price £ Exc. VAT	Price £ Inc. VAT
1200 x 800	700+350+800	500	M8SWS100H	1873.33	2248.00
1200 x 900	700+350+900	500	M8SWS400H	1914.17	2297.00
1400 x 800	900+350+800	500	M8SWS200H	1929.17	2315.00
1400 x 900	900+350+900	500	M8SWS500H	1970.83	2365.00
1500 x 800	1000+350+800	500	M8SWS300H	1955.83	2347.00
1500 x 900	1000+350+900	500	M8SWS600H	1996.67	2396.00

Please Note: We recommend a minimum opening space of 500mm.

Wetroom Panels with Hinged Swivel Panel						
Size	Tray Finish Adjustment	Front Panel	Swivel Panel	Code	Price £ Exc. VAT	Price £ Inc. VAT
1050	1015-1035	700	350	M8SW251	1018.33	1222.00
1250	1215-1235	900	350	M8SW261	1075.83	1291.00
1350	1315-1335	1000	350	M8SW271	1102.50	1323.00

Please Note: We recommend a minimum opening space of 500mm.



## 8 Series Folding Panels

Folding 8mm wetroom panels offers you the choice of a single wetroom panel, perfect for tight spaces, or a double wetroom panel which creates an enclosed corner situation. Choices to create the space you desire.

### features

- » Height 1950mm
- » Solid chrome double handle
- » Cover caps
- » Space saving solution
- » Inward and outward opening swing
- » Concealed fixings
- » Reversible
- » Wetroom compatible



Folding Wetroom Panel

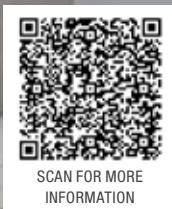

SCAN FOR MORE INFORMATION



Folding Panel / Double - open

#### Folding Wetroom Panel

Size	Adjustment	Code	Price £ Exc. VAT	Price £ Inc. VAT
760	680-700	M87111	1051.67	1262.00
800	720-740	M87211	1087.50	1305.00
900	820-840	M87221	1147.50	1377.00
1000	920-940	M87231	1185.83	1423.00

Please Note: We recommend fitting this product in a Wetroom situation only.

#### Double Folding Wetroom Panels

Size	Adjustment	Code	Price £ Exc. VAT	Price £ Inc. VAT
760 x 760	715-735	M86101H	2003.33	2404.00
800 x 800	755-775	M86102H	2072.50	2487.00
900 x 900	855-875	M86103H	2207.50	2649.00
1000 x 1000	955-975	M86104H	2280.00	2736.00

Please Note: We recommend fitting this product in a Wetroom situation only

# MERLYN™

## Wetroom Collection

Coming Soon  
New Colours & Swivel Panels  
in Fluted Glass

Gun Metal  
Grey

Brushed  
Nickel









**Add Colour;**  
Express yourself



Stabilising Bracing Bar - Colour options



Ceiling Bracing Bar - Colour options



Angled Bracing Bar - Chrome Only

NEW

# WHY CHOOSE OUR NEW 8MM WETROOM PANELS FOR YOUR BATHROOM

Simple yet stylish, our new 8mm Wetroom Panels offer you the choice to mix and match many combinations of shapes and sizes to any space you require. At MERLYN we understand that every wetroom space is different, which is why we have designed a modular system of wetroom panels that can be combined to fit any area. We have broken the range down to 17 key components with additional fitting options which you can build together to make up the full wetroom of your choice. It's as simple as A, B, C.



LIFETIME GUARANTEE



2015 MM HEIGHT STANDARD RANGE



8 MM GLASS THICKNESS



MERSHIELD™ STAYCLEAR

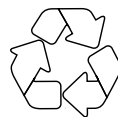

ECO FRIENDLY PACKAGING



EASY CLEAN GLASS

## Colour Options...



Standard Chrome



BBR = Brushed Brass



MB = Matt Black



BBZ = Brushed Bronze

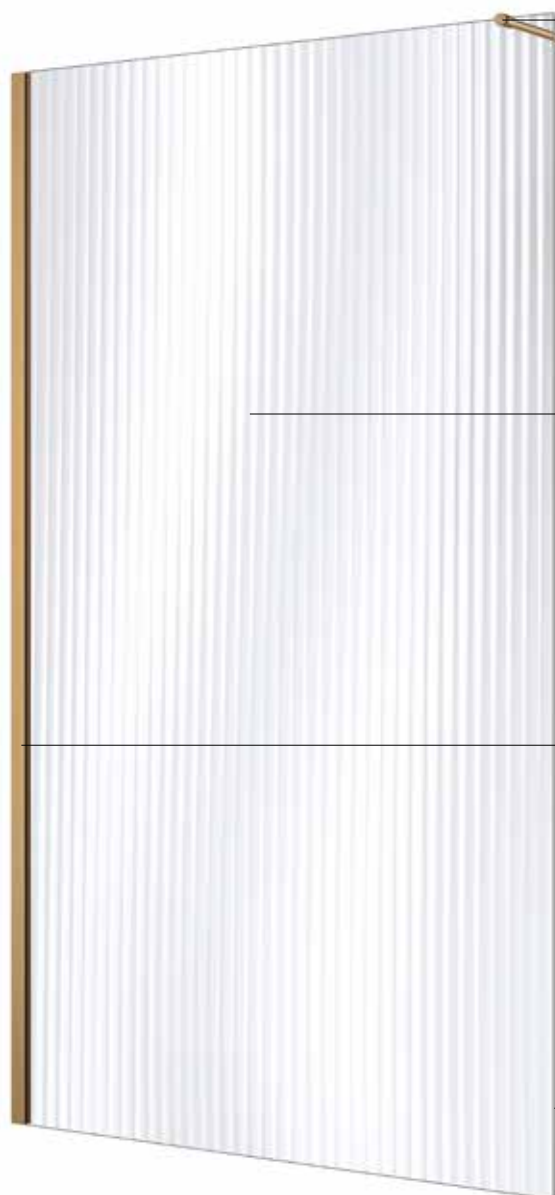

Round elegant bracing bar

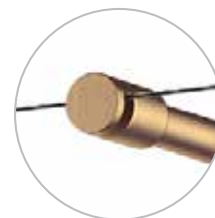

\*Fluted glass - with low iron consistency for that clear glass finish

\*Our fluted glass is an alternative option to our standard clear glass

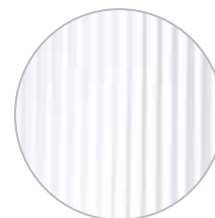

Strong and sturdy construction

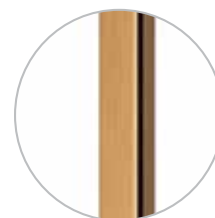

No PVC seals



# Wetroom Configurations



*Wetroom Panel*



*Wetroom Panel / With Vertical Post*



*Wetroom Panel / With End Panel*





Wetroom Panel / With End Panel & Swivel Panel



Corner Wetroom Panel



Wetroom Panel / With Swivel Panel

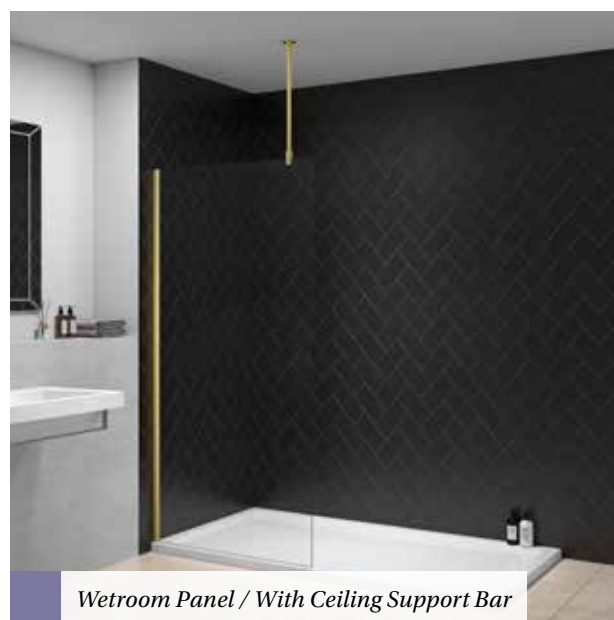

Wetroom Panel / With Ceiling Support Bar

**How it works:** To make up a Walk In wetroom to fit on a 1200mm x 800mm tray or area floor space. You pick panel A (700mm) and panel B (800mm), this also includes the recommended 500mm minimum opening for the Walk In.

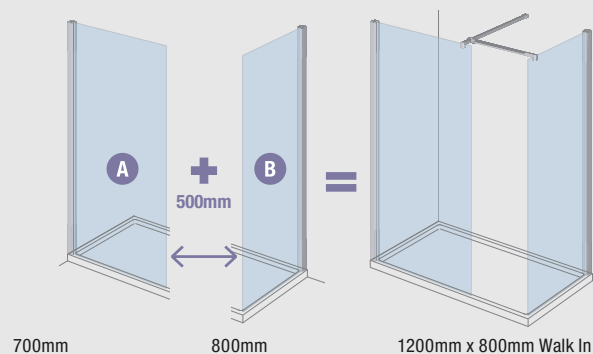





Wetroom Panel / Shown in Chrome

**How it works:** To make up a Walk In wetroom to fit on a 1200mm x 800mm tray or area floor space. You pick panel A (700mm) and panel B (800mm), this also includes the recommended 500mm minimum opening for the Walk In.

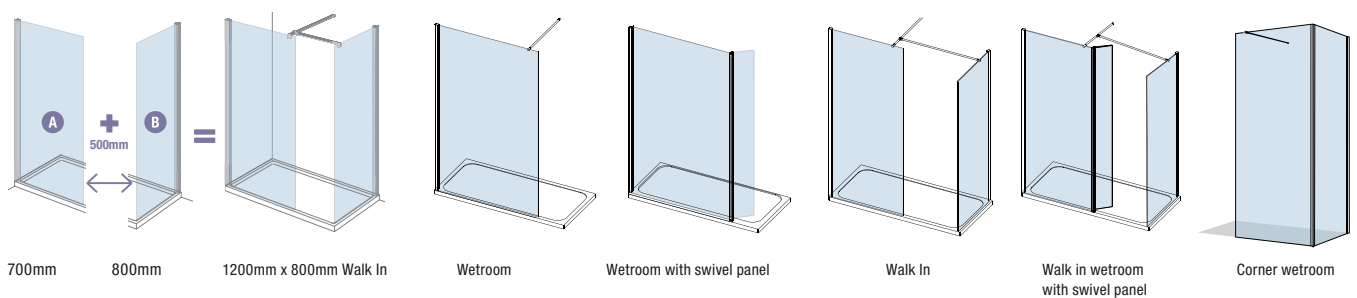



## 8mm Wetroom Panels - Chrome

Choose from a variety of shapes and sizes with our 8mm Wetroom Panels in Chrome. Our modular system allows seamless customization for any wetroom space.

### features

- » Height 2015mm (including rail)
- » Reversible
- » All panels from 700mm & above come with a 1000mm stabilising bar
- » Strong & sturdy construction
- » 3m support post can be retro-fitted to glass thicknesses of 8mm & 10mm
- » Suitable for recess or corner situation
- » Swivel panel can be retrofitted to any 8mm shower wall
- » Corner profile option available

Wetroom Panels					
Ref	Size	Adjustment	Code	Price £ Exc. VAT	Price £ Inc. VAT
A	300	275-290	8W30	240.00	288.00
B	400	375-390	8W40	248.33	298.00
C	500	475-490	8W50	256.67	308.00
D	600	575-590	8W60	270.00	324.00
E	700	675-690	8W70	290.00	348.00
F	760	735-750	8W76	293.33	352.00
G	800	775-790	8W80	295.83	355.00
H	900	875-890	8W90	300.00	360.00
I	1000	975-990	8W10	329.17	395.00
J	1100	1075-1090	8W11	354.17	425.00
K	1200	1175-1190	8W12	356.67	428.00
L	1400	1375-1390	8W14	410.83	493.00
M	1600	1575-1590	8W16	465.00	558.00

Please Note: Panels A-H are the only panels that can be used as an end panel. Panels A-D do not come with a stabilising bar / Panels E-M come with stabilising bar. All panels 700mm and above come with 1000mm straight bracing bar. Sizes 700mm-900mm come with T-shape bracket to join two bracing bars.

Additional Options					
Ref	Size	Product	Code	Price £ Exc. VAT	Price £ Inc. VAT
N	200	Swivel panel	8WSV20	162.50	195.00
O	300	Swivel panel	8WSV30	170.83	205.00
P	400	Swivel panel	8WSV40	183.33	220.00
Q	3000	Vertical ceiling post	3MCP	133.33	160.00
R	2000	Corner post profile	8WCR	62.50	75.00
S	1000	Round bracing bar	N126CH	133.33	160.00
T	1500	Round bracing bar	N127CH	162.50	195.00
U	-	Round T- piece bracket	A04S0010	45.83	55.00
V	350	Angled stabilising bar	SP08SCU12320	95.83	115.00
W	400	Vertical ceiling bracing bar	CBB440	115.00	138.00

Note: 3m vertical ceiling post can be retro-fitted to glass thickness of 8mm. Corner profile post is suitable for L-shape corner situations only & recommend using a stabilising bar for all size panels with this configuration. Corner Profile must be used with two Wetroom Panels. Round bracing bar can be retrofitted to 8mm glass.



### Technical drawing

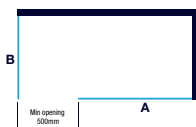



Wetroom Panel / Shown in Brushed Bronze

## **Add Colour;** Express yourself

When ordering your wetroom panel, please add the desired colour code to the end of the standard chrome code.

**Example:** 8W12 is the standard chrome code add **MB** for Matt Black, **BBR** for Brushed Brass or **BBZ** for Brushed Bronze.

**E.G. 8W12MB = 8W12 Matt Black.**

Standard Chrome

**MB** = Matt Black

**BBR** = Brushed Brass

**BBZ** = Brushed Bronze







## 8mm Wetroom Panels - Colour

Choose from a variety of shapes, sizes and finishes with our 8mm Wetroom Panels in Colour. Our modular system allows seamless customization for any wetroom space.

Available in Matt Black, Brushed Brass and Brushed Bronze.

### features

- » Height 2015mm (including rail)
- » All panels from 700mm & above come with a 1000mm stabilising bar
- » Strong & sturdy construction
- » 3m support post can be retro-fitted to glass thickness of 8mm
- » Suitable for recess or corner situation
- » Swivel panel can be retrofitted to any 8mm wetroom panel
- » Reversible
- » Corner profile option available

Wetroom Panels						
Ref	Size	Adjustment	Code	Colour Code	Price £ Exc. VAT	Price £ Inc. VAT
A	300	275-290	8W30	add <b>MB / BBR</b> or <b>BBZ</b>	335.83	403.00
B	400	375-390	8W40	add <b>MB / BBR</b> or <b>BBZ</b>	344.17	413.00
C	500	475-490	8W50	add <b>MB / BBR</b> or <b>BBZ</b>	352.50	423.00
D	600	575-590	8W60	add <b>MB / BBR</b> or <b>BBZ</b>	365.83	439.00
E	700	675-690	8W70	add <b>MB / BBR</b> or <b>BBZ</b>	385.83	463.00
F	760	735-750	8W76	add <b>MB / BBR</b> or <b>BBZ</b>	389.17	467.00
G	800	775-790	8W80	add <b>MB / BBR</b> or <b>BBZ</b>	391.67	470.00
H	900	875-890	8W90	add <b>MB / BBR</b> or <b>BBZ</b>	395.83	475.00
I	1000	975-990	8W10	add <b>MB / BBR</b> or <b>BBZ</b>	425.00	510.00
J	1100	1075-1090	8W11	add <b>MB / BBR</b> or <b>BBZ</b>	450.00	540.00
K	1200	1175-1190	8W12	add <b>MB / BBR</b> or <b>BBZ</b>	452.50	543.00
L	1400	1375-1390	8W14	add <b>MB / BBR</b> or <b>BBZ</b>	506.67	608.00
M	1600	1575-1590	8W16	add <b>MB / BBR</b> or <b>BBZ</b>	560.83	673.00

Please Note: Panels A-H are the only panels that can be used as an end panel. Panels A-D do not come with a stabilising bar / Panels E-M come with stabilising bar. All panels 700mm and above come with 1000mm straight bracing bar. Sizes 700mm -900mm come with T-shape bracket to join two bracing bars.

Additional Options						
Ref	Size	Product	Code	Colour Code	Price £ Exc. VAT	Price £ Inc. VAT
O	300	Swivel panel	8WSV30	add <b>MB / BBR</b> or <b>BBZ</b>	237.50	285.00
Q	3000	Vertical ceiling post	3MCP	add <b>MB / BBR</b> or <b>BBZ</b>	175.00	210.00
R	2000	Corner post profile	8WCR	add <b>MB / BBR</b> or <b>BBZ</b>	104.17	125.00
S	1000	Round bracing bar	N126	add <b>MB / BBR</b> or <b>BBZ</b>	175.00	210.00
T	1500	Round bracing bar	N127	add <b>MB / BBR</b> or <b>BBZ</b>	204.17	245.00
U	-	Round T- piece bracket	A04S0010	add <b>MB / BBR</b> or <b>BBZ</b>	75.00	90.00
W	400	Vertical ceiling bracing bar	CBB440	add <b>MB / BBR</b> or <b>BBZ</b>	133.33	160.00

Note: 3m vertical ceiling post can be retro-fitted to glass thickness of 8mm. Corner profile post is suitable for L-shape corner situations only & recommend using a stabilising bar for all size panels with this configuration. Corner Profile must be used with two Wetroom Panels.

Tray Accessories				
Size	Add-On	Code	Price £ Exc. VAT	Price £ Inc. VAT
-	White Waste Cap	DWASCAPWHT	20.00	24.00

Waste Cap for Touchstone, Mstone & Upstand trays comes in standard chrome. Please use code above for white waste cap. Level25 tray waste cap comes in standard white.



Wetroom / with Vertical Post



Wetroom Panel / with End Panel



### Technical drawing

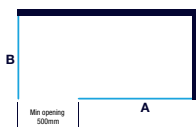





Wetroom Panel / With fluted glass shown in Brushed Brass

**Add Colour;**  
Express yourself

When ordering your wetroom panel, please add the desired colour code to the end of the standard chrome code.

**Example:** 8WFL12 is the standard chrome code add **MB** for Matt Black, **BBR** for Brushed Brass or **BBZ** for Brushed Bronze.

**E.G. 8WFL12MB = 8WFL12 Matt Black.**

Standard Chrome

**MB** = Matt Black

**BBR** = Brushed Brass

**BBZ** = Brushed Bronze





## 8mm Wetroom Panels - Fluted Glass

Discover our new fluted glass option, available in a variety of shapes and sizes. Our modular system allows seamless customization for any wetroom space. Our fluted glass range is available in 6 sizes.

### features

- » Height 2015mm (including rail)
- » 8mm opti-glass tested to EN14428 standards
- » All panels from 700mm & above come with a 1000mm stabilising bar
- » Strong & sturdy construction
- » 3m support post can be retro-fitted to glass thicknesses of 8mm
- » Suitable for recess or corner situation
- » Reversible
- » Corner profile option available

### Wetroom Panels

Ref	Size	Product	Code	Colour Code	Price £ Exc. VAT	Price £ Inc. VAT
E	700	675-690	8WFL70	add <b>MB / BBR</b> or <b>BBZ</b>	656.67	788.00
G	800	775-790	8WFL80	add <b>MB / BBR</b> or <b>BBZ</b>	665.83	799.00
H	900	875-890	8WFL90	add <b>MB / BBR</b> or <b>BBZ</b>	673.33	808.00
I	1000	975-990	8WFL10	add <b>MB / BBR</b> or <b>BBZ</b>	722.50	867.00
J	1100	1075-1090	8WFL11	add <b>MB / BBR</b> or <b>BBZ</b>	765.00	918.00
K	1200	1175-1190	8WFL12	add <b>MB / BBR</b> or <b>BBZ</b>	770.00	924.00

Please Note: Panels E-H are the only panels that can be used as an end panel. All panels 700mm and above come with 1000mm straight bracing bar. Sizes 700mm -900mm come with T-shape bracket to join two bracing bars.

### Additional Options - Colour

Ref	Size	Product	Code	Colour Code	Price £ Exc. VAT	Price £ Inc. VAT
Q	3000	Vertical ceiling post	3MCP	add <b>MB / BBR</b> or <b>BBZ</b>	175.00	210.00
R	2000	Corner post profile	8WCR	add <b>MB / BBR</b> or <b>BBZ</b>	104.17	125.00
S	1000	Round bracing bar	N126	add <b>MB / BBR</b> or <b>BBZ</b>	175.00	210.00
T	1500	Round bracing bar	N127	add <b>MB / BBR</b> or <b>BBZ</b>	204.17	245.00
U	-	Round T-piece bracket	A04S0010	add <b>MB / BBR</b> or <b>BBZ</b>	75.00	90.00
W	400	Vertical ceiling bracing bar	CBB440	add <b>MB / BBR</b> or <b>BBZ</b>	133.33	160.00

Note: 3m vertical ceiling post can be retro-fitted to glass thickness of 8mm. Corner profile post is suitable for L-shape corner situations only & recommend using a stabilising bar for all size panels with this configuration. Corner Profile must be used with two wetroom panels.

### Additional Options - Chrome

Ref	Size	Product	Code	Price £ Exc. VAT	Price £ Inc. VAT
Q	3000	Vertical ceiling post	3MCP	133.33	160.00
R	2000	Corner post profile	8WCR	62.50	75.00
S	1000	Round bracing bar	N126CH	133.33	160.00
T	1500	Round bracing bar	N127CH	162.50	195.00
U	-	Round T- piece bracket	A04S0010	45.83	55.00
V	350	Angled stabilising bar	SP08SCU12320	95.83	115.00
W	400	Vertical ceiling bracing bar	CBB440	115.00	138.00

Note: 3m vertical ceiling post can be retro-fitted to glass thickness of 8mm. Corner profile post is suitable for L-shape corner situations only & recommend using a stabilising bar for all size panels with this configuration. Corner Profile must be used with two Wetroom Panels. Round bracing bar can be retrofitted to 8mm glass.

### Tray Accessories

Size	Add-On	Code	Price £ Exc. VAT	Price £ Inc. VAT
-	White Waste Cap	DWASCAPWHT	20.00	24.00

Waste Cap for Touchstone, Mstone & Upstand trays comes in standard chrome. Please use code above for white waste cap. Level25 tray waste cap comes in standard white.



### Technical drawing

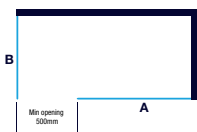



*Framed Wetroom*

*Technical drawing*







## 8mm Squared Framed Wetrooms - Black

Our Framed Wetroom Panels are the best to arrive onto the scene. Creating a feature of your showering space, a Showerwall or Walk-In feature, this statement piece gives your bathroom the wow it's been waiting for.

### features

- » Height 2000
- » Anodised finish - The colour layer is fully integrated with the underlying aluminium substrate, so it cannot chip or peel. Making it more durable than powder coating.
- » Bracing bar sits flush with shower panel
- » Mersfield Stayclear™
- » 8mm toughened glass

#### Squared Wetroom - Black Only

Size	Adjustment	Code	Price £ Exc. VAT	Price £ Inc. VAT
900	875 - 890	BLKFSWCTL90	916.67	1100.00
1000	975 - 990	BLKFSWCTL100	958.33	1150.00
1200	1175 - 1190	BLKFSWCTL120	1000.00	1200.00

Bracing bar comes as standard on all sizes. All sizes come with black square T-piece bracket to ajoin two bracing bars.

#### Double Entry Squared Wetroom - Black Only

Size	Adjustment	Code	Price £ Exc. VAT	Price £ Inc. VAT
1200	-	BLKFSWCTL120D	1166.67	1400.00

Bracing bar comes as standard on all sizes.

#### Framed Wetroom Panels - Black Only

Size	Adjustment	Code	Price £ Exc. VAT	Price £ Inc. VAT
800	775-790	BLKFSW80	791.67	950.00
900	875-890	BLKFSW90	812.50	975.00
1000	975-990	BLKFSW100	833.33	1000.00
1200	1175-1190	BLKFSW120	875.00	1050.00

Wetroom Panel is reversible. Available in Matt Black only (Not available in Chrome). Comes with a 1m bracing bar. Sizes 800mm and 900mm comes with a T-bracket as standard.

#### Additional Options

Size	Product	Code	Price £ Exc. VAT	Price £ Inc. VAT
400	Vertical ceiling support bar	B0040MB	142.50	171.00
1.5M	Optional support bar	B0029MB	98.33	118.00

#### Tray Accessories

Size	Add-On	Code	Price £ Exc. VAT	Price £ Inc. VAT
-	White Waste Cap	DWASCAPWHT	20.00	24.00

Waste Cap for Touchstone, Mstone & Upstand trays comes in standard chrome. Please use code above for white waste cap. Level25 tray waste cap comes in standard white.



Squared Showerwall / Black only



Squared Walk-In / Black only





4<sup>MM</sup>  
GLASS  
THICKNESS

6<sup>MM</sup>  
GLASS  
THICKNESS

8<sup>MM</sup>  
GLASS  
THICKNESS

10<sup>MM</sup>  
GLASS  
THICKNESS

LIFETIME  
GUARANTEE

MERSHIELD<sup>™</sup>  
STAYCLEAR

# MERLYN<sup>™</sup> | Bath Screens

## Innovation meets aesthetics

Innovative design and contemporary aesthetics bring this bathroom favourite to life. This modern collection has been created with the same superb materials and unrelenting attention to detail demonstrated across all MERLYN ranges.

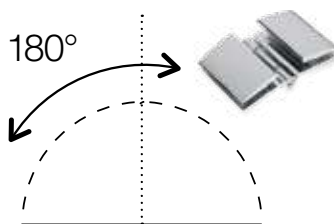

### **180° inwards swing**

*The signature piece of this range, the Two Panel Hinged Bath Screen features a secure 180° inwards swing which means you can position the glass where you can comfortably deflect water into the bath and not on to the floor!*

### **Rise and fall**

*All MERLYN Bath Screens have a rise and fall hinge to make it easier for you to open.*

# MERLYN *bath screens*

**.SecureSeal.**  
by MERLYN

6<sup>MM</sup>  
GLASS  
THICKNESS

LIFETIME  
GUARANTEE

MERSHIELD™  
STAYCLEAR

## The Ultimate Leak-free Bath Screen Range

The SecureSeal by MERLYN has been designed with a leak free sealing arm which extends from the profile to create a complete seal between the bath and screen. When not in use the arm simply folds away back into the profile.

SecureSeal by MERLYN offers functional and easy to use designs to complement any bathroom space. With glass screen heights of 1500mm and 6mm glass, our SecureSeal by MERLYN range allows you to enjoy peace of mind in a leak free shower experience for years to come.

This range has been designed with the same superb materials and unrelenting attention to detail demonstrated across all MERLYN ranges.

## How SecureSeal works

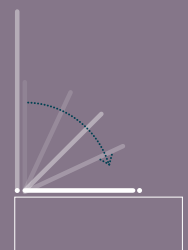

**01.**  
Pull down arm from storage position.

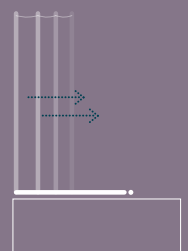

**02.**  
Extend screen and locate panels.

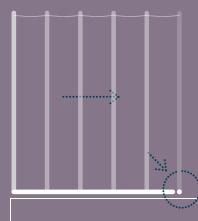

**03.**  
Fully extend and clip into position for a secure fit and tight seal.

SecureSeal Lock



This is the SecureSeal Leak Free Sealing Arm



# some unique features

## MERLYN EASY-FIT

### Replace your Bath Screen with Ease

An innovative way to replace your bath screen without the need to re-drill the wall. Simply connect your easy-fit to the existing holes in the wall and install your new bath screen.



**NO DRILLING**



SCAN FOR  
EASY-FIT VIDEO

## HydraSEAL

### Exclusive to MERLYN Bath Screens

HydraSEAL acts as an extra barrier, sealing the gap between the seal and the pivot point where water can usually escape.

It contains a high density foam that compresses onto the bath screen to form a tight seal and restricts water escaping from this problem area.

### Fitting Steps

Easy-Fit profile



**01.**  
Remove the  
old profile



Slide  
bracket  
up to align  
with hole

**02.**  
Position the  
EASY-fit profile  
on the wall



**03.**  
Adjust the  
brackets to align  
to the existing  
holes and fix in  
position



HydraSEAL  
creates a barrier  
to restrict leaking!

**EASY FIT** and **HydraSEAL** are Available with following Bath Screens: **MB1 / MB2 / MB3 / MB3A / MB3B / MB3C**



# SecureSeal Single Panel

## features

- » Mershield Stayclear™ protected glass
- » Reversible
- » Lifetime Guarantee



# SecureSeal 4 Fold

## features

- » Mershield Stayclear™ protected glass
- » Reversible
- » Lifetime Guarantee



### SecureSeal Single Panel

Size	Code	Panel	Product Adjustment	Price £ Exc. VAT	Price £ Inc. VAT
800 x 1500	MS1	1	780 - 800mm	360.00	432.00

### SecureSeal 4 Fold

Size	Code	Panel	Product Adjustment	Price £ Exc. VAT	Price £ Inc. VAT
800 x 1500	MS4	4	780 - 800	605.83	727.00

## Technical drawing



A: Moving Panels (screen width when folded into the bath 712mm)

○ Recommended shower head position

## Technical drawing



A: Moving Panels (screen width when folded into the bath 226mm)  
B: Fixed Panel

○ Recommended shower head position

# SecureSeal 5 Fold

## features

- » Mershield Stayclear™ protected glass
- » Reversible
- » Lifetime Guarantee



### SecureSeal 5 Fold

Size	Code	Panel	Product Adjustment	Price £ Exc. VAT	Price £ Inc. VAT
1000 x 1500	MS5	5	980 - 1000	681.67	818.00

## Technical drawing



A: Moving Panels (screen width when folded into the bath 178mm)

☐ Recommended shower head position

# SecureSeal Fixed Panel

## features

- » Mershield Stayclear™ protected glass
- » Reversible
- » Lifetime Guarantee



### SecureSeal Fixed Panel

Size	Code	Panel	Product Adjustment	Price £ Exc. VAT	Price £ Inc. VAT
300 x 1500	MSFP	1	300 -320	292.50	351.00

## Technical drawing

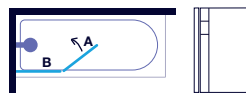

A: Moving Panel  
B: Fixed Panel

☐ Recommended shower head position

## Single Square Fixed Panel

### features

- » 6mm toughened safety glass
- » Reversible



## Single Curved

### features

- » 6mm toughened safety glass
- » Reversible
- » Featuring HydraSeal



### Single Square Fixed Panel

Size	Code	Panel	Product Adjustment	Price £ Exc. VAT	Price £ Inc. VAT
800 x 1500	MB0	1	785-800	164.17	197.00

### Single Curved

Size	Code	Panel	Product Adjustment	Price £ Exc. VAT	Price £ Inc. VAT
800 x 1500	MB1	1	780-800	224.17	269.00

### Single Curved - Easy-Fit Bundle

800 x 1500	MB1FLEX	1	780-800	286.67	344.00
------------	---------	---	---------	--------	--------

### Technical drawing



B - Fixed Panel

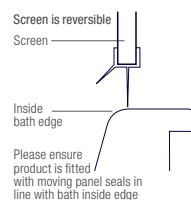

○ Recommended shower head position

### Technical drawing



A - Moving Panel  
Y - Radius of swing = 733mm  
Door swings 90° inwards and outwards

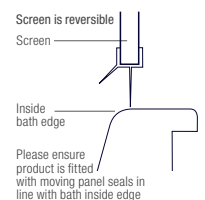

○ Recommended shower head position

# Single Square

## features

- » 6mm toughened safety glass
- » Reversible
- » Featuring HydraSeal



# Single Square with Towel Rail

## features

- » 6mm toughened safety glass
- » Reversible
- » Featuring HydraSeal
- » Includes towel rail



BATH SCREENS

### Single Square

Size	Code	Panel	Product Adjustment	Price £ Exc. VAT	Price £ Inc. VAT
800 x 1500	MB2	1	780-800	265.00	318.00

### Single Square - Easy-Fit Bundle

800 x 1500	MB2FLEX	1	780-800	325.83	391.00
------------	---------	---	---------	--------	--------

### Single Square With Towel Rail

Size	Code	Panel	Product Adjustment	Price £ Exc. VAT	Price £ Inc. VAT
800 x 1500	MB2T	1	780-800	339.17	407.00

## Technical drawing



A - Moving Panel  
Y - Radius of swing = 733mm  
Door swings 90° inwards and outwards

○ Recommended shower head position

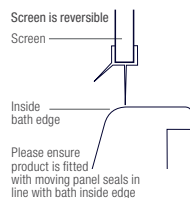

## Technical drawing



A - Moving Panel  
Y - Radius of swing = 733mm  
Door swings 90° inwards and outwards

○ Recommended shower head position



## 2 Panel Curved

### features

- » 6mm toughened safety glass
- » Reversible
- » Featuring HydraSeal
- » Includes towel rail



2 Panel Curved					
Size	Code	Panel	Product Adjustment	Price £ Exc. VAT	Price £ Inc. VAT
1150 x 1500	MB3	2	1130 - 1150	638.33	766.00
2 Panel Curved - EASY-FIT BUNDLE					
1150 x 1500	MB3FLEX	2	1130 - 1150	672.50	807.00

### Technical drawing

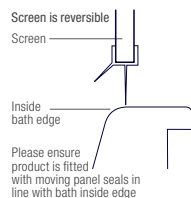

- A - Moving Panel
- B - Fixed Panel
- Y - Radius of swing = 733mm
- Door swings 90° inwards and outwards
- Recommended shower head position

## 2 Panel Folding Curved

### features

- » 6mm toughened safety glass
- » Reversible
- » Featuring HydraSeal



2 Panel Folding Curved					
Size	Code	Panel	Product Adjustment	Price £ Exc. VAT	Price £ Inc. VAT
900 x 1500	MB3A	2	880 - 900	370.00	444.00
2 Panel Folding Curved - EASY-FIT BUNDLE					
900 x 1500	MB3AFLEX	2	880 - 900	426.67	512.00

### Technical drawing

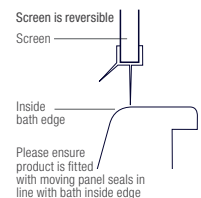

- A - Moving Panel
- B - Fixed Panel
- Y - Radius of swing = 483mm
- Door swings 90° inwards and outwards
- Recommended shower head position

## 2 Panel Folding Square

### features

- » 6mm toughened safety glass
- » Reversible
- » Featuring HydraSeal



#### 2 Panel Square

Size	Code	Panel	Product Adjustment	Price £ Exc. VAT	Price £ Inc. VAT
900 x 1500	MB3B	2	880 - 900	370.00	444.00

#### 2 Panel Square - EASY-FIT BUNDLE

900 x 1500	MB3BFLEX	2	880 - 900	426.67	512.00
------------	----------	---	-----------	--------	--------

### Technical drawing



- A - Moving Panel
- B - Fixed Panel
- Y - Radius of swing = 483mm
- Door swings 90° inwards and outwards
- Recommended shower head position

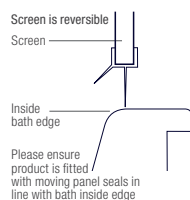

## 2 Panel Curved

### features

- » 6mm toughened safety glass
- » Reversible
- » Featuring HydraSeal



#### 2 Panel Curved

Size	Code	Panel	Product Adjustment	Price £ Exc. VAT	Price £ Inc. VAT
900 x 1500	MB3C	2	880 - 900	373.33	448.00

#### 2 Panel Curved - EASY-FIT BUNDLE

900 x 1500	MB3CFLEX	2	880 - 900	426.67	512.00
------------	----------	---	-----------	--------	--------

### Technical drawing



- A - Moving Panel
- B - Fixed Panel
- Y - Radius of swing = 383mm
- Door swings 90° inwards and outwards
- Recommended shower head position

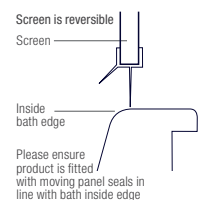

## 4 Fold

### features

- » 4mm toughened safety glass
- » Reversible



4 Fold					
Size	Code	Panel	Product Adjustment	Price £ Exc. VAT	Price £ Inc. VAT
850 x 1400	MB4	4	845 - 850	444.17	533.00

### Technical drawing



A - Moving Panel (Panel width 200mm)

○ Recommended shower head position

## Curved Curtain Rail

### features

- » 6mm toughened safety glass
- » Reversible



Curtain Rail - Curved					
Size	Code	Panel	Product Adjustment	Price £ Exc. VAT	Price £ Inc. VAT
300 x 1500	MB5	1	300 - 320	295.00	354.00

### Technical drawing



B - Fixed Panel  
E - Curtain rail

○ Recommended shower head position

## Curtain Rail

### features

- » 6mm toughened safety glass
- » Reversible



#### Curtain Rail In Recess

Size	Code	Panel	Product Adjustment	Price £ Exc. VAT	Price £ Inc. VAT
300 x 1500	MB5A	1	300 - 320	300.83	361.00

### Technical drawing



Height is 1500mm including rail  
 B - Fixed Panel  
 E - Curtain rail

Recommended shower head position

## Hinged Square

### features

- » 8mm toughened safety glass
- » Reversible



#### Hinged Square

Size	Code	Panel	Product Adjustment	Price £ Exc. VAT	Price £ Inc. VAT
850 x 1500	MB6	1	850 - 870	594.17	713.00

### Technical drawing



Y - Radius of swing = 810mm  
 Door swings 90° outwards only

Recommended shower head position

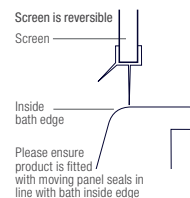



## 2 Panel Hinged

### features

- » 8mm toughened safety glass
- » This product is handed



## 2 Panel Fixed with Hinged Panel

### features

- » 8mm toughened safety glass
- » This product is handed



2 Panel Hinged - Left Hand And Right Hand					
Size	Code	Panel	Product Adjustment	Price £ Exc. VAT	Price £ Inc. VAT
900 x 1500	MB7L Left Handed	2	880 - 900	717.50	861.00
900 x 1500	MB7R Right Handed	2	880 - 900	717.50	861.00

2 Panel Fixed With Hinge Panel - Left Hand And Right Hand					
Size	Code	Panel	Product Adjustment	Price £ Exc. VAT	Price £ Inc. VAT
900 x 1500	MB7AL Left Handed	2	830 - 850	696.67	836.00
900 x 1500	MB7AR Right Handed	2	830 - 850	696.67	836.00

### Technical drawing

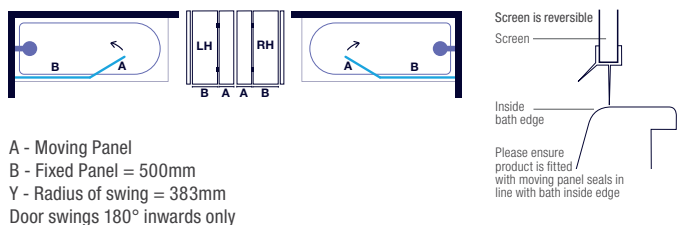

○ Recommended shower head position

### Technical drawing

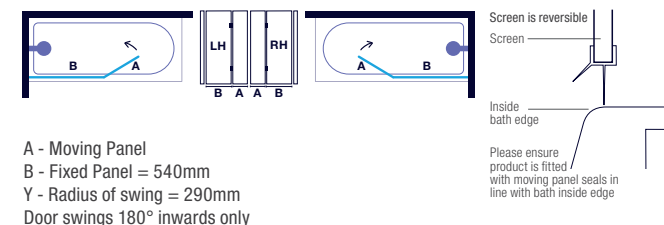

○ Recommended shower head position

# Two Panel Hinged - Black

## features

- » Available in Chrome & Matt Black
- » 8mm toughened glass
- » Anodised aluminium matte black finish - more durable than powder coating
- » This product is handed



BATH SCREENS

### MERLYN Black Hinged 2 Panel - Left Hand And Right Hand

Size	Code	Panel	Product Adjustment	Price £ Exc. VAT	Price £ Inc. VAT
900 x 1500	BLKMB7L	2	880-890	725.00	860.90
900 x 1500	BLKMB7R	2	880-890	725.00	860.90

## Technical drawing

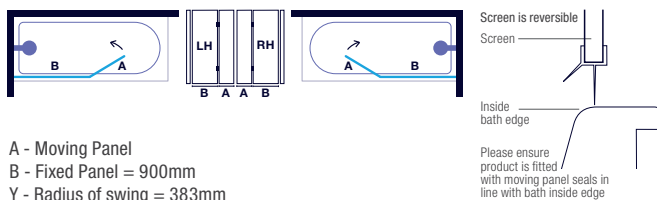

A - Moving Panel  
 B - Fixed Panel = 900mm  
 Y - Radius of swing = 383mm  
 Door swings 180° inwards only

☐ Recommended shower head position

## 2 Panel Folding

### features

- » 8mm toughened safety glass
- » Reversible



## 3 Panel Folding

### features

- » 8mm toughened safety glass
- » Reversible



### 2 Panel Folding

Size	Code	Panel	Product Adjustment	Price £ Exc. VAT	Price £ Inc. VAT
1100 x 1500	MB8	2	1080 - 1100	720.83	865.00

### 3 Panel Folding

Size	Code	Panel	Product Adjustment	Price £ Exc. VAT	Price £ Inc. VAT
1400 x 1500	MB9	3	1380 - 1400	910.00	1092.00

### Technical drawing

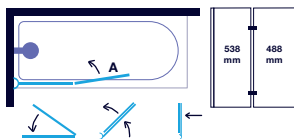

A - Moving Panel  
 B - Fixed Panel  
 Y - Radius of swing = 570mm  
 Door swings 90° inwards and outwards

○ Recommended shower head position

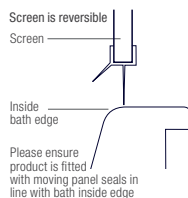

### Technical drawing

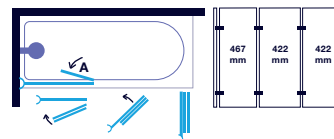

Y - Panel Swing  
 Screen swing 90° inwards & outwards

○ Recommended shower head position

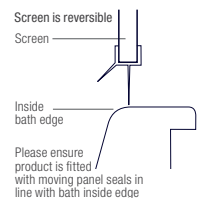

# Single Square

## features

- » 8mm toughened safety glass
- » Reversible
- » Includes towel rail



# Single Curved

## features

- » 8mm toughened safety glass
- » Reversible



### Single Square

Size	Code	Panel	Product Adjustment	Price £ Exc. VAT	Price £ Inc. VAT
800 x 1500	MB10	1	780 - 800	602.50	723.00

### Single Curved

Size	Code	Panel	Product Adjustment	Price £ Exc. VAT	Price £ Inc. VAT
800 x 1500	MB11	1	780 - 800	516.67	620.00

## Technical drawing

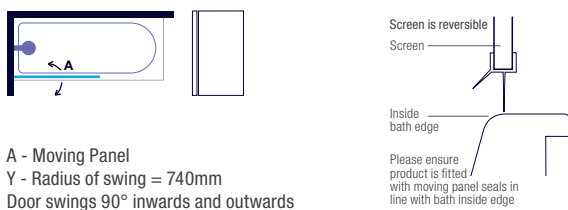

○ Recommended shower head position

## Technical drawing

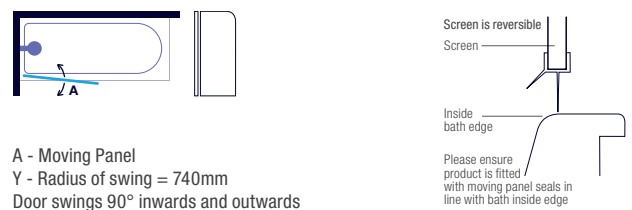

○ Recommended shower head position



# Single Square

## features

- » 5mm toughened safety glass
- » Reversible



# 2 Panel Folding

## features

- » 6mm toughened safety glass
- » Reversible



Single Square					
Size	Code	Panel	Product Adjustment	Price £ Exc. VAT	Price £ Inc. VAT
800 x 1400	MB12	1	790 - 800	175.00	210.00

2 Panel Folding					
Size	Code	Panel	Product Adjustment	Price £ Exc. VAT	Price £ Inc. VAT
1100 x 1500	MB13	2	1080 - 1100	585.00	702.00

## Technical drawing

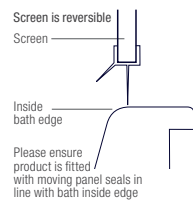
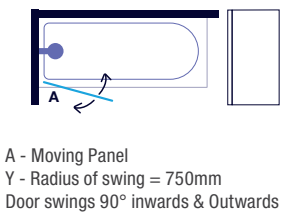

○ Recommended shower head position

## Technical drawing

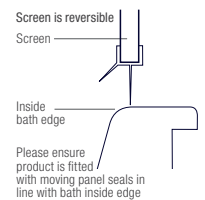
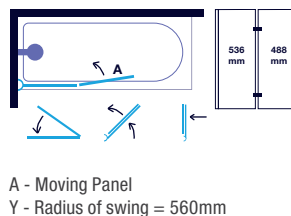

○ Recommended shower head position

## Fixed Single Square - Colour

### features

- » 8mm toughened glass
- » Anodised aluminium finish - more durable than powder coating
- » Reversible
- » 4 Colour finishes
- » Minimalist frameless design

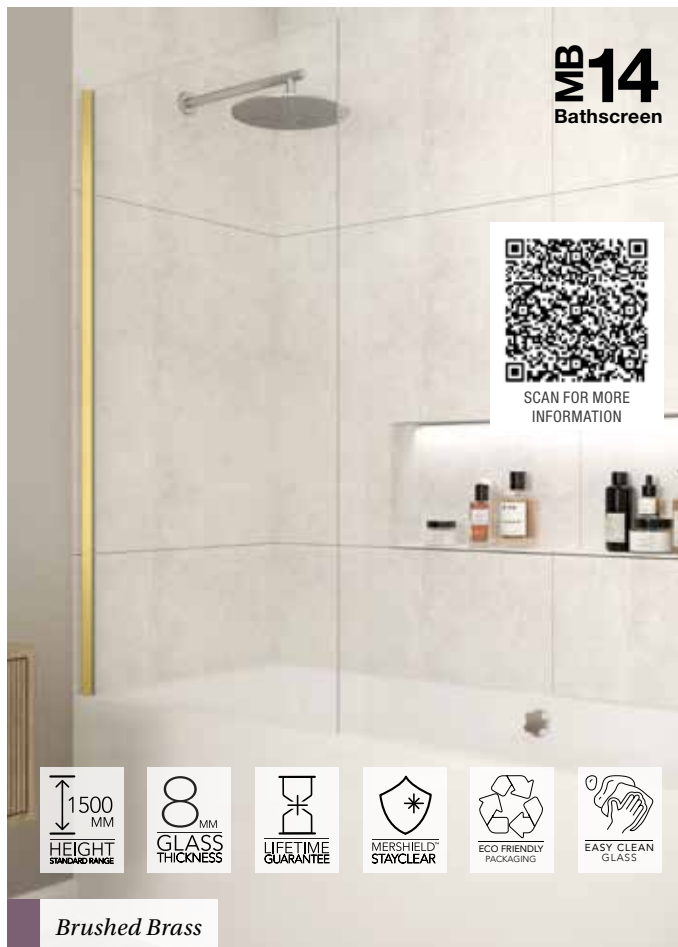

## Fixed Framed - Colour

### features

- » 8mm toughened glass
- » Anodised aluminium finish - more durable than powder coating
- » Reversible
- » Fully framed design
- » 3 Colour finishes

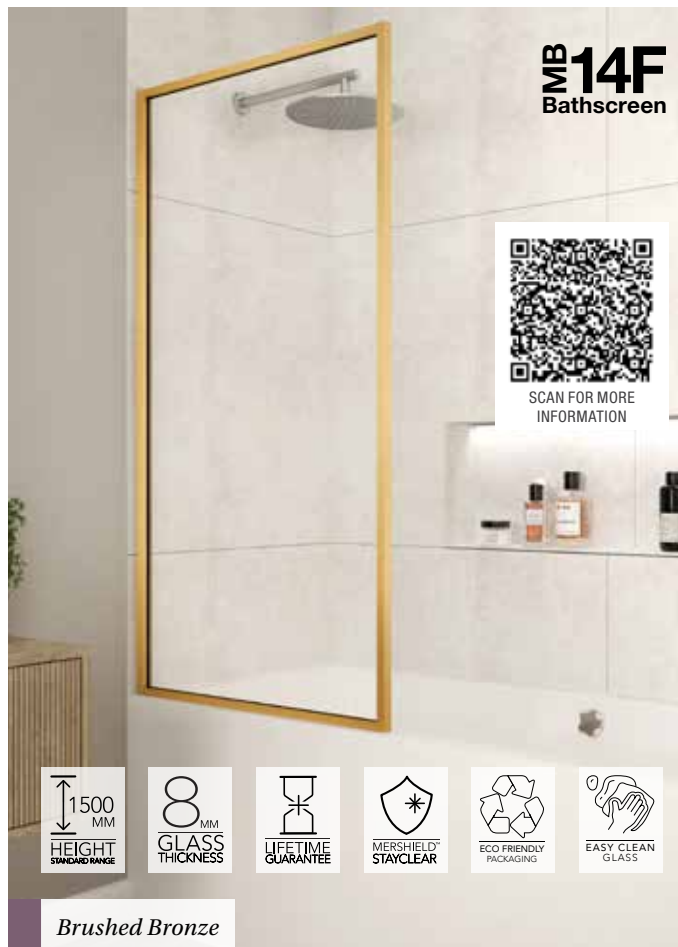

BATH SCREENS

MERLYN Fixed Square						
Size	Code	Colour Code	Panel	Product Adjustment	Price £ Exc. VAT	Price £ Inc. VAT
800 x 1500	MB14	Chrome only code	1	785-800	266.67	320.00
800 x 1500	MB14	add <b>MB</b> / <b>BBR</b> or <b>BBZ</b>	1	785-800	266.67	320.00

MERLYN Fixed Framed						
Size	Code	Colour Code	Panel	Product Adjustment	Price £ Exc. VAT	Price £ Inc. VAT
800 x 1500	MB14F	add <b>MB</b> / <b>BBR</b> or <b>BBZ</b>	1	775-790	366.67	440.00
Not available in chrome						

### Technical drawing

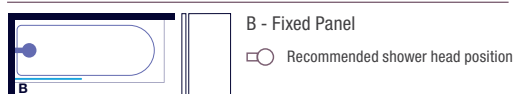

### Technical drawing

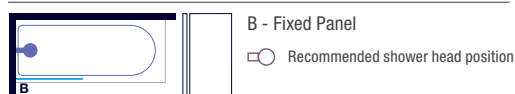

When ordering your bath screen please add the desired colour code to the end of the standard chrome code.

**Example:** MB14 is the standard chrome code add **MB** for Matt Black, **BBR** for Brushed Brass or **BBZ** for Brushed Bronze.

**E.G. MB14MB = MB14 Matt Black.**

Standard Chrome **MB** = Matt Black **BBR** = Brushed Brass **BBZ** = Brushed Bronze





# MERLYN™ | trays

## Sculpted, elegance & durability

Beautifully sculpted shower trays, angled and contoured to match all enclosures and spaces, achieving the perfect combination of luxury, elegance and durability.

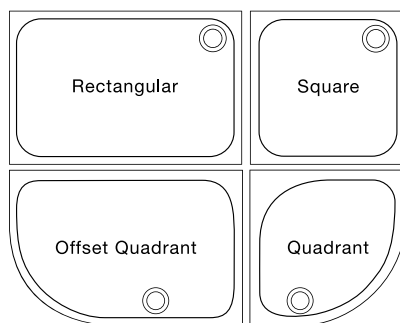

Offset Quad is handed. Please choose L for Left or R for Right when ordering.

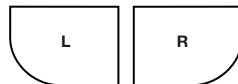

Left Handed (L) Right Handed (R)





MERLYN Truestone Shower Tray - Graphite

Choose your colour?



White  
Code W

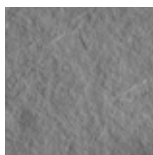

Fossil Grey  
Code F



Graphite  
Code G

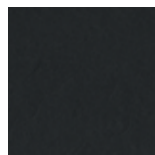

Black  
Code B



Sandstone  
Code S



# TRUESTONE®

Beautifully handcrafted and ultra-low slate trays, elegant in appearance and luxurious to touch. With 5 finishes to choose from. These trays will bring an element of natural beauty and a truly designer finish to your bathroom.

## features

- » Ultra Slim: only 30mm in height.
- » Handcrafted from high grade stone resin.
- » Integrated Discreet Waste.
- » Luxurious Textured Finish.
- » Can be fitted on or level with floor.
- » Comes with 90mm Fast Flow Waste.
- » Our self cleaning vortex design: Offers a maintenance free solution as it doesn't require any cleaning.

### Rectangular & Square Trays (add the colour code to the below codes to order)

Size	Code	Price £ Exc. VAT	Price £ Inc. VAT
900 x 900	T90RT	490.00	588.00
1000 x 800	T108RT	465.83	559.00
1200 x 800	T128RT	551.67	662.00
1200 x 900	T129RT	619.17	743.00
1400 x 800	T148RT	613.33	736.00
1400 x 900	T149RT	674.17	809.00
1500 x 800	T158RT	648.33	778.00
1500 x 900	T159RT	825.00	990.00
1600 x 800	T168RT	692.50	831.00
1600 x 900	T169RT	894.17	1073.00
1700 x 800	T178RT	760.00	912.00
1700 x 900	T179RT	923.33	1108.00

All trays come with a MERLYN 90mm fast flow waste.  
All tray codes need the corresponding colour code on the opposite page e.g. T108RTW

### Quadrant Tray (add the colour code to the below codes to order)

Size	Code	Price £ Exc. VAT	Price £ Inc. VAT
900 x 900	T90Q	438.33	526.00

### Offset Quadrant Tray (add the colour code to the below codes to order)

Size	Code	Price £ Exc. VAT	Price £ Inc. VAT
1000 x 800	T108H (L or R)	575.00	690.00
1200 x 900	T129H (L or R)	674.17	809.00

This product is handed – please choose L for Left Hand and R for Right Hand when ordering. All tray codes need the corresponding colour code on the opposite page e.g. T108RTW

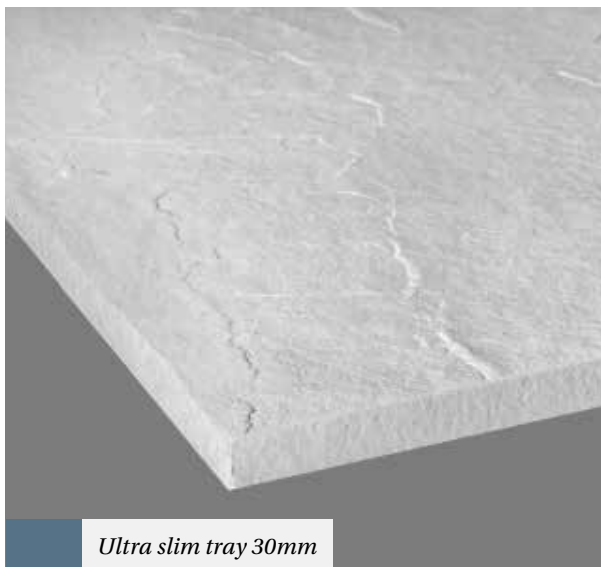
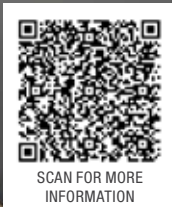

Ultra slim tray 30mm



MERLYN branded Waste Cover



**Level25 Tray**

*Tray types*



Square tray



Level25 Rectangle tray



Quadrant tray

**Please note:**

The Level 25 tray must be fitted with the waste positioned along the back wall and **not** to the front.



\*Quadrant tray is handed – please choose L for Left Hand and R for Right Hand when ordering.



25 YEARS  
GUARANTEE



EASY  
CLEAN



SCAN FOR MORE  
INFORMATION

## LEVEL 25<sup>1</sup>

The luxury satin look and feel is designed to give confidence while not feeling harsh underfoot.

### features

- » Ultra slim 25mm low level tray
- » Sleek minimalist design
- » Discreet integrated waste cover
- » Can be fitted on or level with floor
- » Comes with 90mm fast flow waste
- » Shower tray 25 year guarantee
- » Available in square, rectangular and quadrant

### Rectangular & Square Trays

Size	Code	Price £ Exc. VAT	Price £ Inc. VAT
900 x 900	L90SQ	388.33	466.00
1000 x 800	L108RT	388.33	466.00
1000 x 900	L109RT	424.17	509.00
1100 x 800	L118RT	424.17	509.00
1100 x 900	L119RT	428.33	514.00
1200 x 700	L127RT	428.33	514.00
1200 x 760	L1276RT	428.33	514.00
1200 x 800	L128RT	432.50	519.00
1200 x 900	L129RT	437.50	525.00
1300 x 800	L138RT	630.83	757.00
1300 x 900	L139RT	643.33	772.00
1400 x 760	L1476RT	649.17	779.00
1400 x 800	L148RT	625.00	750.00
1400 x 900	L149RT	625.00	750.00
1500 x 800	L158RT	679.17	815.00
1500 x 900	L159RT	679.17	815.00
1600 x 800	L168RT	700.83	841.00
1600 x 900	L169RT	707.50	849.00
1700 x 760	L1776RT	728.33	874.00
1700 x 800	L178RT	796.67	956.00
1700 x 900	L179RT	810.00	972.00

All trays come with a MERLYN 90mm fast flow waste.

### Quadrant Tray

Size	Code	Price £ Exc. VAT	Price £ Inc. VAT
900 x 900	L90Q	450.00	540.00
*1200 x 900	L129QL	635.00	762.00
*1200 x 900	L129QR	635.00	762.00

All trays come with a MERLYN 90mm fast flow waste.

This product is handed – please choose L for Left Hand and R for Right Hand when ordering.





**Level25-SR Tray**

*Tray types*



Square tray



Level25-SR Rectangle tray



Quadrant tray

**Please note:**  
The Level 25 tray must be fitted with the waste positioned along the back wall and **not** to the front.



\*Quadrant tray is handed – please choose L for Left Hand and R for Right Hand when ordering.



25 YEARS  
GUARANTEE



EASY  
CLEAN

# LEVEL 25<sup>1</sup>-SR

We have carried out all the testing to give you and your family the peace of mind of showering in a safe environment and the splendour of this natural stone effect.

## features

- » Ultra slim 25mm low level tray
- » Slip-resistant is manufactured into the coating and won't wear
- » Sleek minimalist design
- » Discreet integrated waste cover
- » Can be fitted on or level with floor
- » Comes with 90mm fast flow waste
- » Shower tray 25 year guarantee
- » Available in square, rectangular and quadrant

### Rectangular & Square Trays

Size	Code	Price £ Exc. VAT	Price £ Inc. VAT
900 x 900	L90SQAS	562.50	675.00
1000 x 800	L108RTAS	551.67	662.00
1000 x 900	L109RTAS	613.33	736.00
1100 x 800	L118RTAS	613.33	736.00
1100 x 900	L119RTAS	613.33	736.00
1200 x 700	L127RTAS	613.33	736.00
1200 x 800	L128RTAS	590.00	708.00
1200 x 900	L129RTAS	620.83	745.00
1300 x 800	L138RTAS	913.33	1096.00
1300 x 900	L139RTAS	913.33	1096.00
1400 x 760	L1476RTAS	921.67	1106.00
1400 x 800	L148RTAS	896.67	1076.00
1400 x 900	L149RTAS	896.67	1076.00
1500 x 800	L158RTAS	964.17	1157.00
1500 x 900	L159RTAS	982.50	1179.00
1600 x 800	L168RTAS	995.00	1194.00
1600 x 900	L169RTAS	1005.00	1206.00
1700 x 800	L178RTAS	1131.67	1358.00
1700 x 900	L179RTAS	1139.17	1367.00

All trays come with a MERLYN 90mm fast flow waste.

### Quadrant Tray

Size	Code	Price £ Exc. VAT	Price £ Inc. VAT
900 x 900	L90QAS	639.17	767.00
*1200 x 900	L129QLAS	901.67	1082.00
*1200 x 900	L129QRAS	901.67	1082.00

All trays come with a MERLYN 90mm fast flow waste.

This product is handed – please choose L for Left Hand and R for Right Hand when ordering.

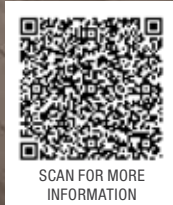

SCAN FOR MORE  
INFORMATION



SCAN FOR video



*Exceeds Class C for DIN 51097 - Barefoot ramp test.  
This ranks MERLYN in a premium class.*



*Touchstone Tray*

*Design details*



Graduated adjustable leg and easy-fit tray panel kit.



Adjustable leg system.



90mm fast flow waste, includes hair trap and chrome cover.



Left Handed (L) Right Handed (R)

\*Quadrant tray is handed – please choose L for Left Hand and R for Right Hand when ordering.

Sizes 1700 x 800mm and above do not come with a tray panel kit.



10 YEARS  
GUARANTEE

## TOUCHSTONE

Beautifully sculpted shower trays, angled and contoured to match enclosures and spaces, achieving the perfect combination of luxury, elegance and durability.

### features

- » 10 Year Guarantee
- » 50mm high to achieve minimalist design
- » Available as low level or with tray panel kits for easy installation
- » Compatible 90mm fast flow waste also available
- » More than 30 sizes available

#### Rectangular & Square Trays - Waste not included

Size	Code	Tray Panel Kit	Price £ Exc. VAT	Price £ Inc. VAT
700 x 700	S70SQTO	Kit 4	114.17	137.00 NEW
760 x 760	S76SQTO	Kit 4	113.33	136.00
800 x 800	S80SQTO	Kit 4	132.50	159.00
900 x 900	S90SQTO	Kit 4	148.33	178.00
800 x 700	S870RTTO	Kit 4	172.50	207.00
800 x 760	S876RTTO	Kit 4	172.50	207.00
900 x 700	S970RTTO	Kit 4	189.17	227.00
900 x 760	S976RTTO	Kit 4	189.17	227.00
900 x 800	S980RTTO	Kit 4	189.17	227.00
1000 x 700	S107RTTO	Kit 4	195.83	235.00
1000 x 760	S1076RTTO	Kit 4	195.83	235.00
1000 x 800	S108RTTO	Kit 4	195.83	235.00
1000 x 900	S109RTTO	Kit 4	203.33	244.00
1100 x 760	S1176RTTO	Kit 4	204.17	245.00
1100 x 800	S118RTTO	Kit 4	203.33	244.00
1100 x 900	S119RTTO	Kit 4	212.50	255.00
1200 x 700	S127RTTO	Kit 4	203.33	244.00
1200 x 760	S1276RTTO	Kit 4	213.33	256.00
1200 x 800	S128RTTO	Kit 4	225.83	271.00
1200 x 900	S129RTTO	Kit 4	243.33	292.00
1300 x 800	S138RTTO	Kit 3	316.67	380.00
1300 x 900	S139RTTO	Kit 3	331.67	398.00
1400 x 700	S147RTTO	Kit 3	329.17	395.00
1400 x 760	S1476RTTO	Kit 3	326.67	392.00
1400 x 800	S148RTTO	Kit 3	326.67	392.00
1400 x 900	S149RTTO	Kit 3	344.17	413.00
1500 x 700	S157RTTO	Kit 3	368.33	442.00
1500 x 760	S1576RTTO	Kit 3	384.17	461.00
1500 x 800	S158RTTO	Kit 3	389.17	467.00
1500 x 900	S159RTTO	Kit 3	404.17	485.00
1600 x 700	S167RTTO	Kit 3	434.17	521.00
1600 x 760	S1676RTTO	Kit 3	434.17	521.00
1600 x 800	S168RTTO	Kit 3	434.17	521.00
1600 x 900	S169RTTO	Kit 3	450.83	541.00
1685 x 700	S177RTTO	Kit 3	465.00	558.00
1680 x 760	S1776RTTO	Kit 3	480.00	576.00
1700 x 800*	S178RTTO	Kit 3	522.50	627.00
1700 x 900*	S179RTTO	Kit 3	563.33	676.00
1800 x 700*	S187RTTO	Kit 3	602.50	723.00
1800 x 800*	S188RTTO	Kit 3	643.33	772.00
1800 x 900*	S189RTTO	Kit 3	661.67	794.00

\*Waste is centred on 1700x800 - 1800x900 trays. See Page 151 for Tray Panel Kit Information. Size 1700x800mm and above does not come with a tray panel kit

#### Quadrant Tray - Waste not included

Size	Code	Tray Panel Kit	Price £ Exc. VAT	Price £ Inc. VAT
800 x 800	S80QTO	Kit 2	140.00	168.00
900 x 900	S90QTO	Kit 2	156.67	188.00
1000 x 1000	S100QTO	Kit 2	180.83	217.00

#### Offset Quadrant Tray - Waste not included

900x760 LH	S976QLTO	Kit 1	190.83	229.00
900x760 RH	S976QRTO	Kit 1	190.83	229.00
1000 x 800 LH	S108QLTO	Kit 1	215.00	258.00
1000 x 800 RH	S108QRTO	Kit 1	215.00	258.00
1200 x 800 LH	S128QLTO	Kit 1	225.83	271.00
1200 x 800 RH	S128QRTO	Kit 1	225.83	271.00
1200 x 900 LH	S129QLTO	Kit 1	267.50	321.00
1200 x 900 RH	S129QRTO	Kit 1	267.50	321.00

This product is handed – please choose L for Left Hand and R for Right Hand when ordering. See Page 151 for Tray Panel Kit Information. Waste Cap for Touchstone, Mstone & Upstand trays comes in standard chrome. Please use code DWASCAPWHT for white waste cap.

#### Tray Accessories

	Code	Price £ Exc. VAT	Price £ Inc. VAT
White Waste Cap	DWASCAPWHT	20.00	24.00
Complete Waste	DWAS	40.00	48.00

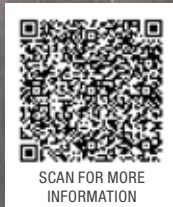

SCAN FOR MORE  
INFORMATION





*Touchstone-SR Tray*

*Design details*



Graduated adjustable leg and easy-fit tray panel kit.



Adjustable leg system.



90mm fast flow waste, includes hair trap and chrome cover.



Left Handed (L) Right Handed (R)

\*Quadrant tray is handed – please choose L for Left Hand and R for Right Hand when ordering.



# TOUCHSTONE-SR

We have carried out all the testing to give you and your family the peace of mind of showering in a safe environment and the splendour of this natural stone effect.

## features

- » 10 Year Guarantee
- » 50mm high to achieve minimalist design
- » Available as low level or with tray panel kits for easy installation
- » Slip-resistant is manufactured into the coating and won't wear
- » Compatible 90mm fast flow waste also available
- » More than 30 sizes available

### Rectangular & Square Trays

Size	Code	Tray Panel Kit	Price £ Exc. VAT	Price £ Inc. VAT
800 x 800	S80SQASTO	Kit 4	182.50	219.00
900 x 900	S90SQASTO	Kit 4	207.50	249.00
900 x 800	S98ORTASTO	Kit 4	264.17	317.00
1000 x 800	S108RTASTO	Kit 4	272.50	327.00
1000 x 900	S109RTASTO	Kit 4	283.33	340.00
1100 x 800	S118RTASTO	Kit 4	283.33	340.00
1200 x 700	S127RTASTO	Kit 4	283.33	340.00
1200 x 760	S1276RTASTO	Kit 4	297.50	357.00
1200 x 800	S128RTASTO	Kit 4	315.00	378.00
1200 x 900	S129RTASTO	Kit 4	338.33	406.00
1400 x 700	S147RTASTO	Kit 3	453.33	544.00
1400 x 800	S148RTASTO	Kit 3	453.33	544.00
1400 x 900	S149RTASTO	Kit 3	477.50	573.00
1500 x 760	S1576RTASTO	Kit 3	532.50	639.00
1500 x 800	S158RTASTO	Kit 3	535.00	642.00
1500 x 900	S159RTASTO	Kit 3	560.00	672.00
1600 x 700	S167RTASTO	Kit 3	597.50	717.00
1600 x 800	S168RTASTO	Kit 3	597.50	717.00
1600 x 900	S169RTASTO	Kit 3	624.17	749.00
1685 x 700	S177RTASTO	Kit 3	644.17	773.00
1700 x 800	S178RTASTO	Kit 3	722.50	867.00
1700 x 900	S179RTASTO	Kit 3	778.33	934.00

\*Waste is centred on 1700x800 & 1700x900 trays.

### Quadrant Tray

Size	Code	Tray Panel Kit	Price £ Exc. VAT	Price £ Inc. VAT
800 x 800	S80QASTO	Kit 2	199.17	239.00
900 x 900	S90QASTO	Kit 2	220.00	264.00
*1000 x 800	S108QLASTO LH	Kit 1	286.67	344.00
*1000 x 800	S108QRASTO RH	Kit 1	286.67	344.00
*1200 x 800	S128QLASTO LH	Kit 1	315.00	378.00
*1200 x 800	S128QRASTO RH	Kit 1	315.00	378.00
*1200 x 900	S129QLASTO LH	Kit 1	372.50	447.00
*1200 x 900	S129QRASTO RH	Kit 1	372.50	447.00

This product is handed – please choose L for Left Hand and R for Right Hand when ordering.

### Tray Panel Kit

Tray Panel Kit	Code	Price £ Exc. VAT	Price £ Inc. VAT
Kit 1	DRK1	141.67	170.00
Kit 2	DRK2	141.67	170.00
Kit 3	DRK3	140.00	168.00
Kit 4	DRK4	136.67	164.00

### Tray Options

	Code	Price £ Exc. VAT	Price £ Inc. VAT
White Waste Cap	DWASCAPWHT	20.00	24.00
Complete Waste	DWAS	40.00	48.00

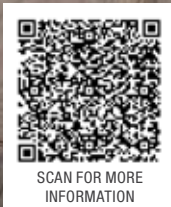

SCAN FOR MORE INFORMATION



*MStone Tray*

*Design details*



Graduated adjustable leg and easy-fit tray panel kit.



Adjustable leg system.



90mm fast flow waste, includes hair trap and chrome cover.

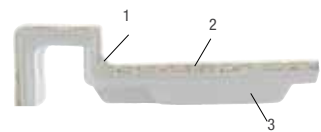

1. Top Acrylic capped ABS layer  
2. Stone Resin  
3. Bottom ABS layer (encapsulates the tray)



# MSTONE

The MStone double skin stone resin tray is sleek and sophisticated in design. A highly engineered tray providing rigidity and strength, combined with a relatively low weight. MStone trays are ideal for 'low level' installation. Alternatively, you can raise your tray. In such cases you will need the MStone shower tray panel kit. MStone panel kits are available separately.

## features

- » Double Skinned for added rigidity
- » 50mm high to achieve minimalist design
- » 135mm high including tray panel set
- » ABS capped acrylic sheets with anti-bacterial properties
- » Comes with 90mm fast flow waste
- » More than 30 sizes available
- » Available with tray panel kits
- » Shower tray lifetime guarantee \*covers manufacturing defects only

### Rectangular Tray (comes with MERLYN 90mm fast flow waste)

Size	Code	Tray Panel Kit*	Price £ Exc. VAT	Price £ Inc. VAT
900 x 760	D976RT	Kit 4	284.17	341.00
1000 x 800	D108RT	Kit 4	322.50	387.00
1100 x 760	D1176RT	Kit 4	365.83	439.00
1100 x 800	D118RT	Kit 4	342.50	411.00
1200 x 700	D127RT	Kit 4	338.33	406.00
1200 x 760	D1276RT	Kit 4	347.50	417.00
1200 x 800	D128RT	Kit 4	343.33	412.00
1200 x 900	D129RT	Kit 4	366.67	440.00
1400 x 800	D148RT	Kit 3	510.00	612.00
1400 x 900	D149RT	Kit 3	530.83	637.00
1500 x 700	D157RT	Kit 3	596.67	716.00
1500 x 800	D158RT	Kit 3	580.83	697.00
1500 x 900	D159RT	Kit 3	591.67	710.00
1600 x 800	D168RT	Kit 3	681.67	818.00
1600 x 900	D169RT	Kit 3	695.00	834.00
1685 x 700	D177RT	Kit 3	701.67	842.00
1680 x 760	D1776RT	Kit 3	701.67	842.00
*1700 x 800	D178RT	Kit 3	809.17	971.00

### Tray Panel Kit (including Legs)

DRK3	Kit 3	140.00	168.00
DRK4	Kit 4	136.67	164.00



\*Waste is centred for 1700 x 800 tray - D178RT

### Tray Panel Kit (including Legs)

Code	Tray Panel Kit	Price £ Exc. VAT	Price £ Inc. VAT
DRK1	Kit 1	141.67	170.00

### Waste Complete

DWAS	Kit 1	40.00	48.00
------	-------	-------	-------

### White Waste Cap Option

DWASCAPWHT		20.00	24.00
------------	--	-------	-------

Waste Cap for Touchstone, Mstone & Upstand trays comes in standard chrome. Please use code above for white waste cap.

\*Tray Panel Kit (Order Separately)  
Please see page 157-158 for important tray information.





# MSTONE

The MStone tray is capped with an easy to clean surface that provides a chemical resistant, anti-bacterial solution due to its ultra-smooth, non-porous surface.



MStone Tray

### Square Tray (comes with MERLYN 90mm fast flow waste)

Size	Code	Tray Panel Kit*	Price £ Exc. VAT	Price £ Inc. VAT
760	D76SQ	Kit 4	185.00	222.00
800	D80SQ	Kit 4	205.00	246.00
900	D90SQ	Kit 4	285.83	343.00

### Tray Panel Kit (including Legs)

DRK4	Kit 4	136.67	164.00
------	-------	--------	--------

### Quadrant Tray (comes with MERLYN 90mm fast flow waste)

Size	Code	Tray Panel Kit*	Price £ Exc. VAT	Price £ Inc. VAT
800	D80Q	Kit 2	261.67	314.00
900	D90Q	Kit 2	283.33	340.00
1000	D100Q	Kit 5	375.00	450.00

### Tray Panel Kit (including Legs)

DRK2	Kit 2	141.67	170.00
DRK5	Kit 5	141.67	170.00

### Offset Quadrant Tray (comes with MERLYN 90mm fast flow waste)

Size	Code	Tray Panel Kit*	Price £ Exc. VAT	Price £ Inc. VAT
900 x 760	D976Q L	Kit 1	393.33	472.00
900 x 760	D976Q R	Kit 1	393.33	472.00
1000 x 800	D108Q L	Kit 1	370.00	444.00
1000 x 800	D108Q R	Kit 1	370.00	444.00
1200 x 800	D128Q L	Kit 1	388.33	466.00
1200 x 800	D128Q R	Kit 1	395.83	475.00
1200 x 900	D129Q L	Kit 1	409.17	491.00
1200 x 900	D129Q R	Kit 1	416.67	500.00

## Tray types



Rectangular Tray



Rectangular Tray with centred waste



Square tray



Quadrant Tray



Offset Quadrant Tray

Image shown as Left Handed (L) Please choose L for Left or R for Right when ordering.



Left Handed (L)



Right Handed (R)

\*Tray Panel Kit (Order Separately)  
Please see pages 157-158 for important tray information.



Rectangular Tray - Shown as right hand



Square Tray - Shown as right hand



SCAN FOR MORE INFORMATION

### Design details

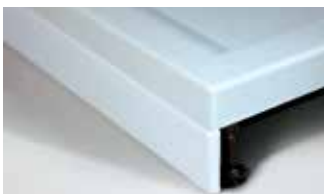

Adjustable legs & tray panel kit



Graduated adjustable leg system



Optional extra 90mm fast flow waste



13mm high upstand

## MERLYN UPSTAND®

Upstands are designed with an additional vertical lip around their perimeter that is tiled over to provide further leak prevention.

### features

- » Single skinned with 4 upstands
- » 50mm high (63mm with upstand)
- » 135mm high with tray panel set (148mm high including upstand)
- » ABS capped acrylic sheet with anti-bacterial properties
- » Available with 90mm branded fast flow waste (optional extra)
- » Available with tray panel kits (optional extra)
- » Optional white waste cap available for Touchstone, Upstand & Mstone trays only.

#### Rectangular Tray - with 4 Upstands

Size	Code	Tray Panel Kit*	Price £ Exc. VAT	Price £ Inc. VAT
900 x 760	S976RTUP	Kit 4	256.67	308.00
1000 x 800	S108RTUP	Kit 4	260.83	313.00
1000 x 800**	S108RTUPCW	Kit 4	260.83	313.00
1200 x 760	S1276RTUP	Kit 4	283.33	340.00
1200 x 800	S128RTUP	Kit 4	300.83	361.00
1200 x 800**	S128RTUPCW	Kit 4	300.83	361.00
1200 x 900	S129RTUP	Kit 4	322.50	387.00
1300 x 800	S138RTUP	Kit 4	410.83	493.00
1400 x 800	S148RTUP	Kit 4	421.67	506.00
1500 x 800	S158RTUP	Kit 4	450.83	541.00
1700 x 800	S178RTUP	Kit 4	599.17	719.00

\*\*Waste is centred on the 1000x800 / 1200x800. See page 157

#### Square Tray- with 4 Upstands

Size	Code	Tray Panel Kit*	Price £ Exc. VAT	Price £ Inc. VAT
760	S76SQUP	Kit 4	161.67	194.00
800	S80SQUP	Kit 4	174.17	209.00
900	S90SQUP	Kit 4	247.50	297.00
900**	S90SQUPCW	Kit 2	247.50	297.00

\*\*Waste is centred on the 900 tray

#### Optional Extra - Rectangle Tray Panel Kit (including Legs)

Code	Tray Panel Kit*	Price £ Exc. VAT	Price £ Inc. VAT
DRK4	Kit 4	136.67	164.00

#### Waste Complete Only

Code	Price £ Exc. VAT	Price £ Inc. VAT
DWAS	40.00	48.00

\*Tray Panel Kit (Order Separately)

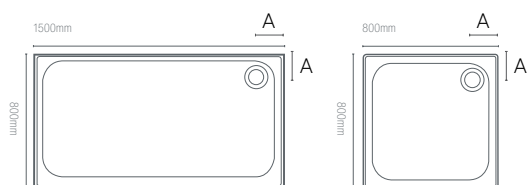

Waste position A = 148MM

Waste position A = 148MM

# Product Information

We have produced this product section to help you with your purchasing decision. For further information please contact your local stockist, details of which can be found at [www.merlynshowering.com](http://www.merlynshowering.com)

## Product information

All products are manufactured in accordance with EN14428 and utilise toughened safety glass to EN 12150.

All shower trays are manufactured in accordance with EN14527.

All doors feature adjustable wall profiles to compensate for out-of-true walls and have micro adjustment features for fine tuning to obtain a perfect fit and operating action.

All enclosures, wetrooms and panels are Power Shower approved – will retain water under normal showering conditions.

Water retention is maintained in all products under normal showering conditions.

A selection of MERLYN enclosures are frameless in design. Spray/mist may escape therefore we would recommend use of these enclosures with tiled floors.

Opened cartons can not be returned. Returns carry a £40 box charge or £60 per unit where the sale is less than 30 days old. Returns over 30 days old will not be accepted.

All products are supplied complete with full installation instructions and the necessary fixings.

Check with your dealer for accurate matching of material samples. Product descriptions do not imply the use of precious or valuable materials.

Our policy of reviewing product design and development on a regular basis means MERLYN reserve the right to change product specifications and prices without notice.

Only shower enclosures, panels, Truestone shower trays and bath screens are covered by the Lifetime Guarantee. Please contact the MERLYN sales team for more details.

Glass shattering and parts subject to wear are not covered by the Lifetime Guarantee.

For full details on all product ranges please contact MERLYN Showering on 0808 1011429 or log onto [www.merlynshowering.com](http://www.merlynshowering.com).

Trays shown in this catalogue are for illustrative purposes only.

## Images are for illustration purposes only.

The colours and finishes shown in the catalogue are as accurate as possible within the limits of the printing process. The positioning of all showering heads in the brochure is for illustrative purposes only.

All descriptions, specifications and particulars contained in this brochure are intended merely to represent a general idea of the products described herein and none of these form part of any contract to give rise to any independent or collateral liability upon the company.

## Cleaning

- » It is important to clean your MERLYN shower door and tray after every use. Wipe down all the glass and metal parts with a soft cloth.
- » Do not allow lime scale to build up in hard water areas.
- » Ensure that any residual water on the glass is removed after every use.
- » Clean the glass regularly using soapy water.
- » Do not use abrasive products on any surfaces.
- » Install the enclosure in a well ventilated area.

## Information and maintenance

Always read the instructions on the packaging, chrome is vulnerable to acid attack and some strong household cleaners including strong disinfectants, denture cleaners, hair dyes, wine making chemicals and photographic chemicals may contain acid. These materials may have a varying effect on the surface from black spots/streaks (which cannot be removed) to pitting the surface. Contact with these materials should be avoided.

## Important shower tray information

It is up to the designer or installer to ensure that the tray and enclosure combination is arranged in such a way that water retention meets the customers needs.

- » The waste has the capacity to carry away 29L/Min. High powered systems may exceed this. Please check with the manufacturer.
- » Please ensure that the shower head is not positioned directly over the waste as this may restrict water flow rate.
- » Please ensure that the colour and size of shower tray are as per your order before installation.
- » You must inspect the product thoroughly before installation. Fitting the product is acceptance of quality.
- » The trays are handmade from natural material. Please allow for height variances due to manufacturing tolerances.
- » For open ended shower screens please consult your installer.
- » Shower trays must be fitted as per the fitting instruction. Deviation from the pre installation checks or fitting installation will void the guarantee.
- » When wet, the surface of the majority of shower trays will show an increase in the potential for slipping. This is particularly the case when soap, shampoo, bath oil etc. are used. It is important that designers, installers and users are aware of this.

## Important

Although shower door and enclosure sizes are related to tray sizes it is important to note that most shower trays are tiled down to the rim, often over an 'up-stand'. The finished installation space may be less than the nominal tray size. MERLYN shower units are made to suit this remaining space.

## Tray Finish min-max

The Tray Finish applies when fitting a door and a tray. These are the minimum and maximum dimensions that a shower door or enclosure will fit using standard wall profiles.

## Tray finish

**To find the correct Tray Finish dimension:**

**In a recess:** Measure from the finished, tiled wall to the opposite finished, tiled wall.

**In a corner:** Measure from the finished, tiled wall to the edge of the tray.

**Note:** If the wall/walls are leaning in, this will further reduce your Tray Finish.

## Adjustment

This is the min and max adjustment of the actual enclosure. These are the adjustment dimensions of the actual door excluding the tray. Therefore, these are the dimensions to follow when installing an enclosure in a wetroom application without a tray.

The guide below may be helpful in taking measurements to determine the shower door or enclosure size required. Dimensions given in this publication are in millimetres, are approximate and may vary with adjustment. They are subject to change without notice.

Please note that when a tray is fitted it is essential that the tray is level before any doors or enclosures are fitted.

## Recess Location

Take the measurements after the tray is installed and the walls are tiled.

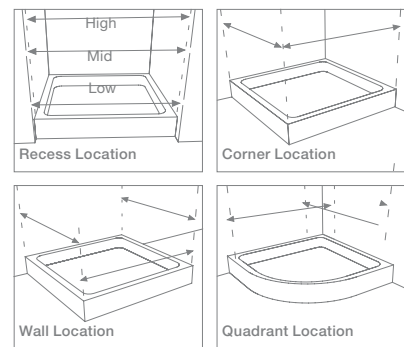

## Bath Screens

- » MERLYN Bath Screens are not designed to fit on baths with stepped fronts, roll top rims or integral soap dishes.
- » Fitting of screen on baths which have raised head rests or shapes is not recommended.
- » There must be no items causing obstruction with the seal and bath, as any of the above may cause leaks.
- » When choosing your Bath Screen, please ensure that if your bath has bath handles, they do not interfere with the bath rim area where your screen will be placed.
- » When choosing an in-swing or folding Bath Screen, please ensure your swing area is not interfering with any brassware or internal shower features. Similarly, when choosing an out-swing, please ensure the out-swing area is free from any obstructions.
- » It is recommended the shower head position is situated on the same wall to which the Bath Screen is fixed and in the centre of the shower area.

# Extension Profiles

## 10 Series Sliding Door

Code	Height	Price £ Exc. VAT	Price £ Inc. VAT
M108EXTSL	1950	131.67	158.00

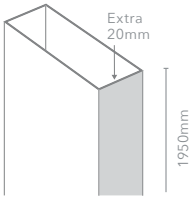

Series 10 extension profile: extra 20mm. Sliding Door can only be used with one extension profile.

## 10 Series Pivot - Hinged Side

Code	Height	Price £ Exc. VAT	Price £ Inc. VAT
M108EXTPVH	2025	131.67	158.00

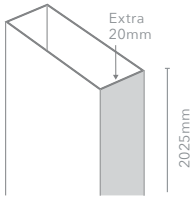

Series 10 extension profile; extra 20mm. Series 10 Pivot Hinge Side extension to be fitted on the same side as the door hinge.

## 10 Series Pivot - Closing Side

Code	Height	Price £ Exc. VAT	Price £ Inc. VAT
M108EXTPV	2000	131.67	158.00

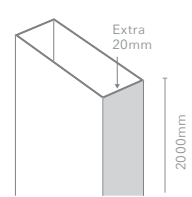

Series 10 extension profile: extra 20mm. Series 10 Pivot Side Panel extension to be fitted on the closing post, Inline Panel or Side Panel side.

## 10 Series Quadrant

Code	Height	Price £ Exc. VAT	Price £ Inc. VAT
M108EXTQU	1850	131.67	158.00

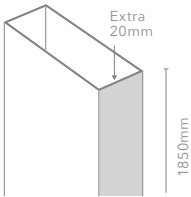

Series 10 extension profile: extra 20mm

## 8 Series Frameless - Hinge & Quadrant Doors

Code	Height	Price £ Exc. VAT	Price £ Inc. VAT
A0614A0	2000	108.33	130.00

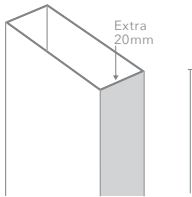

8 Series Frameless extension profile: extra 20mm.

## 8 Series Frameless - Hinged Bifold Door

Code	Height	Price £ Exc. VAT	Price £ Inc. VAT
M8FBEXT20	1950	101.67	122.00

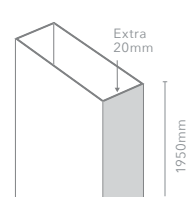

8 Series Frameless extension profile: extra 20mm.

## 8 Series Frameless - Pivot / Pivot & Inline

Code	Height	Price £ Exc. VAT	Price £ Inc. VAT
M8FBEXT20	1950	101.67	122.00

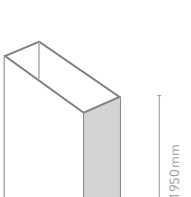

## 8 Series

Code	Height	Price £ Exc. VAT	Price £ Inc. VAT
M8EXT20	1950	99.17	119.00

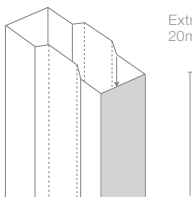

8 Series extension profile: extra 20mm.

## 6 Series Frameless

Code	Height	Price £ Exc. VAT	Price £ Inc. VAT
M8EXT20	2000	99.17	119.00

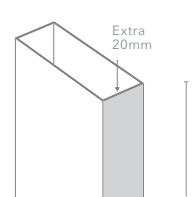

6 Series Frameless extension profile: extra 20mm.

## 6 Series

Code	Height	Price £ Exc. VAT	Price £ Inc. VAT
M6EXT	1900	89.17	107.00

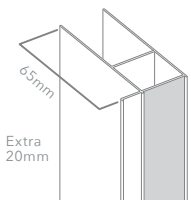

Series 6 extension profile: extra 20mm. No extension profile available for wetroom panels.

## Essence Framed Extension Profile

Code	Height	Price £ Exc. VAT	Price £ Inc. VAT
DWH14B0	1900	105.00	126.00

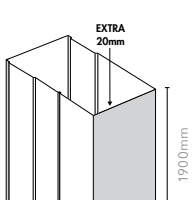

## Essence Sliding & Quadrant Doors

Code	Height	Price £ Exc. VAT	Price £ Inc. VAT
A0114E0	2000	100.00	120.00

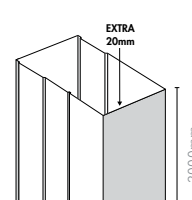

## Essence Hinge & Inline Doors

Code	Height	Price £ Exc. VAT	Price £ Inc. VAT
A0114D0	2000	100.00	120.00

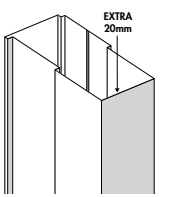

## Express Extension Profile

Code	Height	Price £ Exc. VAT	Price £ Inc. VAT
A0314B0	1900	99.17	119.00

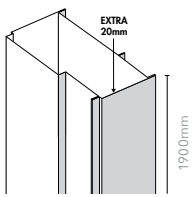

## Source Extension Profile

Code	Height	Price £ Exc. VAT	Price £ Inc. VAT
A1214C0	1850	74.17	89.00

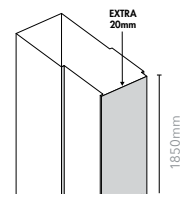

## MERLYN IQ Sliding Door

Code	Height	Price £ Exc. VAT	Price £ Inc. VAT
KAE1	1900	94.17	113.00

## MERLYN IQ Side Panel Extension

KAE3	1900	94.17	113.00
------	------	-------	--------

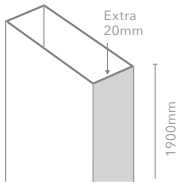

## MERLYN IQ Pivot / Bifold Door

Code	Height	Price £ Exc. VAT	Price £ Inc. VAT
KAE2	1900	94.17	113.00

## MERLYN IQ Side Panel Extension

KAE3	1900	94.17	113.00
------	------	-------	--------

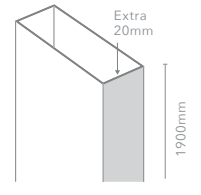



# 8 | series *Inline Panel - Space Solutions*

Our 8 Series range includes the option of additional Inline Panels to ensure the 8 Series can be used in any space from 650mm to 1900mm. Simply choose the adjustment for your space and we will create the ideal combination for you.

## *Inline Panels*

8 Series Inline Panels			
Adjustment / Wetroom - Min-Max	Code*	Price £ Exc. VAT	Price £ Inc. VAT
150	M8P140	405.83	487.00
210	M8P2200	421.67	506.00

## *Infold Door and Inline Panel*

Infold Door and Inline Panel					
Size	Size of Door Supplied	Code	Inline Panel Supplied	Price £ Exc. VAT	Price £ Inc. VAT
650-690	700	M84401	-	1169.17	1403.00
670-710	700	M84401H	EXT.	1143.33	1372.00
710-750	760	M84410	-	1177.50	1413.00
750-790	800	M84411	-	1179.17	1415.00
780-840	700	M84401P1H	150	1419.17	1703.00
840-900	700	M84401P2H	210	1435.83	1723.00
850-890	900	M84421	-	1195.83	1435.00
900-960	760	M84410P1H	210	1453.33	1744.00
950-990	1000	M84431	-	1325.83	1591.00
940-1000	800	M84411P2H	210	1474.17	1769.00
980-1040	900	M84421P1H	150	1473.33	1768.00
1040-1100	900	M84421P2H	210	1580.00	1896.00
1080-1140	1000	M84431P1H	150	1665.00	1998.00
1140-1200	1000	M84431P2H	210	1683.33	2020.00

Please add 20mm to size when using with a Side Panel.  
Optional Side Panel available: See Page 34.

## *Hinge Door and Inline Panel*

Hinge Door and Inline Panel					
Size	Size of Door Supplied	Code	Inline Panel Supplied	Price £ Exc. VAT	Price £ Inc. VAT
650-690	700	M81201	-	1103.33	1324.00
670-710	700	M81201H	EXT.	1084.17	1301.00
710-750	760	M81210	-	1105.83	1327.00
750-790	800	M81211	-	1095.83	1315.00
780-840	700	M81201PH	150	1441.67	1730.00
840-900	700	M81210P1H	210	1376.67	1652.00
850-890	900	M81221	-	1213.33	1456.00
900-960	760	M81210P2H	210	1379.17	1655.00
950-990	1000	M81231	-	1284.17	1541.00
940-1000	800	M81211PH	210	1461.67	1754.00
980-1040	900	M81221P1H	150	1468.33	1762.00
1040-1100	900	M81221P2H	210	1575.00	1890.00
1080-1140	1000	M81231P1H	150	1533.33	1840.00
1140-1200	1000	M81231P2H	210	1643.33	1972.00

Please add 20mm to size when using with a Side Panel.  
Optional Side Panel available: See Page 35.

## *Sliding Door and Inline Panel*

Sliding Door and Inline Panel					
Size	Size of Door Supplied	Code	Inline Panel Supplied	Price £ Exc. VAT	Price £ Inc. VAT
950-990	1000	M88231	-	1197.50	1437.00
1050-1090	1100	M88251	-	1175.00	1410.00
1080-1140	1000	M88231P1H	150	1454.17	1745.00
1140-1200	1000	M88231P2H	210	1559.17	1871.00
1150-1190	1200	M88241	-	1164.17	1397.00
1180-1240	1100	M88251P1H	150	1454.17	1745.00
1240-1300	1100	M88251P2H	210	1559.17	1871.00
1280-1340	1200	M88241P1H	150	1540.83	1849.00
1340-1400	1200	M88241P2H	210	1470.83	1765.00
1250-1290	1300	M88240	-	1428.33	1714.00
1350-1390	1400	M88291	-	1458.33	1750.00
1370-1450	1100	M88251H	150+210	1946.67	2336.00
1450-1490	1500	M88261	-	1509.17	1811.00
1480-1540	1400	M88291P1H	150	1741.67	2090.00
1540-1600	1400	M88291P2H	210	1864.17	2237.00
1550-1590	1600	M88271	-	1527.50	1833.00
1580-1640	1500	M88261P1H	150	1789.17	2147.00
1640-1700	1500	M88261P2H	210	1806.67	2168.00
1650-1690	1700	M88281	-	1601.67	1922.00
1680-1740	1600	M88271P1H	150	1806.67	2168.00
1740-1800	1600	M88271P2H	210	1824.17	2189.00
1780-1840	1700	M88281P1H	150	1989.17	2387.00
1840-1900	1700	M88281P2H	210	2007.50	2409.00

Please add 20mm to size when using with a Side Panel.  
Optional Side Panel available: See Page 31.

# 6 | series *Inline Panel - Space Solutions*

Our 6 Series range includes the option of additional Inline Panels to ensure the 6 Series can be used in any space from 670mm to 1915mm. Simply choose the adjustment for your space and we will create the ideal combination for you.

## *Inline Panels*

6 Series Inline Panels			
Adjustment / Wetroom - Min-Max	Code*	Price £ Exc. VAT	Price £ Inc. VAT
140	M6I125	385.00	462.00
215	M6I200	400.83	481.00

## *Sliding Door and Inline Panel*

Sliding Door and Inline Panel					
Size	Size of Door Supplied	Code	Inline Panel Supplied	Price £ Exc. VAT	Price £ Inc. VAT
950-1000	1000	M68231	-	854.17	1025.00
1050-1100	1100	M68251	-	854.17	1025.00
1065-1140	1000	M68231P1H	140	1299.17	1559.00
1140-1215	1000	M68231P2H	215	1316.67	1580.00
1150-1200	1200	M68241	-	830.83	997.00
1165-1240	1100	M68251P1H	140	1190.00	1428.00
1240-1315	1100	M68251P2H	215	1140.00	1368.00
1265-1340	1200	M68241P1H	140	1190.00	1428.00
1340-1415	1200	M68241P2H	215	1140.00	1368.00
1350-1400	1400	M68291	-	1010.00	1212.00
1360-1460	1100	M68251PPH	140+215	1486.67	1784.00
1450-1500	1500	M68261	-	1075.83	1291.00
1465-1540	1400	M68291P1H	140	1299.17	1559.00
1540-1615	1400	M68291P2H	215	1316.67	1580.00
1550-1600	1600	M68271	-	1136.67	1364.00
1565-1640	1500	M68261P1H	140	1361.67	1634.00
1640-1715	1500	M68261P2H	215	1379.17	1655.00
1650-1700	1700	M68281	-	1136.67	1364.00
1665-1740	1600	M68271P1H	140	1418.33	1702.00
1740-1815	1600	M68271P2H	215	1522.50	1827.00
1765-1840	1700	M68281P1H	140	1418.33	1702.00
1840-1915	1700	M68281P2H	215	1435.83	1723.00

Please add 20mm to size when using with a Side Panel.  
Optional Side Panel available: See Page 39.

## *Pivot Door and Inline panel*

Pivot Door and Inline panel					
Size	Size of Door Supplied	Code	Inline Panel Supplied	Price £ Exc. VAT	Price £ Inc. VAT
670-720	700	M61201 N	-	615.00	738.00
690-740	700	M61201H	EXT	641.67	770.00
740-790	760/800	M61211 N	-	692.50	831.00
785-860	700	M61201P1H	140	960.00	1152.00
850-900	900	M61221 N	-	713.33	856.00
860-935	700	M61211P1H	215	979.17	1175.00
930-1005	760/800	M61211P2H	215	1053.33	1264.00
950-1000	1000	M61231 N	-	765.83	919.00
965-1040	900	M61221P1H	140	1067.50	1281.00
1040-1115	900	M61221P2H	215	1085.83	1303.00
1065-1140	1000	M61231P1H	140	1105.00	1326.00
1140-1215	1000	M61231P2H	215	1123.33	1348.00

Please add 20mm to size when using a Side Panel  
Optional Side Panel available: See page 41.

## *Bifold Door and Inline panel*

Bifold Door and Inline panel					
Size	Size of Door Supplied	Code	Inline Panel Supplied	Price £ Exc. VAT	Price £ Inc. VAT
670-720	700	M67201 N	-	955.00	1146.00
690-740	700	M67201H	EXT	1007.50	1209.00
740-790	760/800	M67211 N	-	937.50	1125.00
785-860	700	M67201PH	140	1287.50	1545.00
850-900	900	M67221 N	-	1023.33	1228.00
860-935	700	M67201P2H	215	1305.83	1567.00
930-1005	760/800	M67211P2H	215	1305.83	1567.00
950-1000	1000	M67231 N	-	1076.67	1292.00
965-1040	900	M67221P1H	140	1354.17	1625.00
1040-1115	900	M67221P2H	215	1372.50	1647.00
1065-1140	1000	M67231P1H	140	1405.00	1686.00
1140-1215	1000	M67231P2H	215	1423.33	1708.00

Please add 20mm to size when using with a Side Panel.  
Optional Side Panel available: See Page 42.

# IONIC Express *Inline Panel - Space Solutions*

Our Ionic express range includes the option of additional Inline Panels to ensure the 8 Series can be used in any space from 650mm to 1900mm. Simply choose the adjustment for your space and we will create the ideal combination for you.

## *Pivot Door and Inline Panels*

Pivot Door and Inline Panel					
Size	Code	Door Size mm	Inline Panel Size mm	Price £ Exc. VAT	Price £ Inc. VAT
650-690	A0306A0	700	-	610.00	732.00
670-710	A030001H	700	EXT.	685.00	822.00
710-750	A0306B0	760	-	594.17	713.00
750-790	A0306D0	800	-	599.17	719.00
780-840	A030002H	700	150	941.67	1130.00
840-900	A030003H	700	210	941.67	1130.00
850-890	A0306E0	900	-	683.33	820.00
900-960	A030004H	760	210	941.67	1130.00
950-990	A0306G0	1000	-	774.17	929.00
940-1000	A030005H	800	210	941.67	1130.00
980-1040	A030006H	900	150	962.50	1155.00
1040-1100	A030007H	900	210	1030.00	1236.00
1080-1140	A030008H	1000	150	1099.17	1319.00
1140-1200	A030009H	1000	210	1099.17	1319.00

## *Sliding Door and Inline Panels*

Sliding Door and Inline Panel					
Size	Code	Door Size mm	Inline Panel Size mm	Price £ Exc. VAT	Price £ Inc. VAT
950-990	A0304A0	1000	-	695.00	834.00
1050-1090	A0304B0	1100	-	695.00	834.00
1080-1140	A030016H	1000	150	974.17	1169.00
1140-1200	A030017H	1000	210	1042.50	1251.00
1150-1190	A0304C0	1200	-	689.17	827.00
1180-1240	A030018H	1100	150	974.17	1169.00
1240-1300	A030019H	1100	210	974.17	1169.00
1280-1340	A030020H	1200	150	1042.50	1251.00
1340-1400	A030021H	1200	210	974.17	1169.00
1350-1390	A0304DH	1400	-	885.83	1063.00
1370-1450	A030022H	1100	150+ 210	1304.17	1565.00
1450-1490	A0304GH	1500	-	943.33	1132.00
1480-1540	A030023H	1400	150	1239.17	1487.00
1540-1600	A030024H	1400	210	1158.33	1390.00
1580-1640	A030025H	1500	150	1296.67	1556.00
1640-1700	A030026H	1500	210	1211.67	1454.00
1650-1690	A0304HH	1700	-	976.67	1172.00
1670-1750	A030027H	1400	150 + 210	1488.33	1786.00
1730-1810	A030028H	1400	210 x 2	1488.33	1786.00
1780-1840	A030029H	1700	150	1243.33	1492.00
1840-1900	A030030H	1700	210	1330.00	1596.00

## *Bifold Door and Inline Panels*

Bifold Door and Inline Panel					
Size	Code	Door Size mm	Inline Panel Size mm	Price £ Exc. VAT	Price £ Inc. VAT
710-750	A0300B0	760	-	665.83	799.00
750-790	A0300C0	800	-	671.67	806.00
850-890	A0300D0	900	-	710.83	853.00
900-960	A030010H	760	210	1012.50	1215.00
950-990	A0300E0	1000	-	826.67	992.00
940-1000	A030011H	800	210	941.67	1130.00
980-1040	A030012H	900	150	988.33	1186.00
1040-1100	A030013H	900	210	1057.50	1269.00
1080-1140	A030014H	1000	150	1099.17	1319.00
1140-1200	A030015H	1000	210	1172.50	1407.00

# Tray Waste Positions

## Truestone Trays

Shape	Size	Waste Position A, mm	Waste Position B, mm
<b>Square</b>		<b>A</b>	<b>B</b>
	900 x 900	270	450

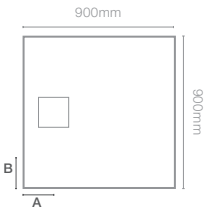

Rectangle	Size	A	B
	1000 x 800	270	400
	1200 x 800	250	400
	1200 x 900	250	450
	1400 x 800	350	400
	1400 x 900	350	450
	1500 x 800	400	400
	1500 x 900	400	450
	1600 x 800	450	400
	1600 x 900	450	450
	1700 x 800	500	400
	1700 x 900	500	450



Quad	Size	A	B
	900 x 900	270	270

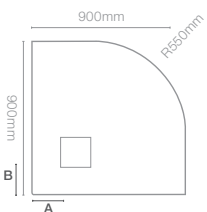

Offset Quad	Size	A	B
	1000 x 800	270	270
	1200 x 900	270	270

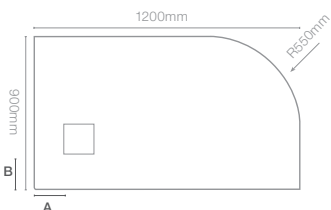

## Level25 & Level25 SR Trays

Shape	Size	Waste Position A, mm	Waste Position B, mm
<b>Square</b>		<b>A</b>	<b>B</b>
	900 x 900	121.5	450

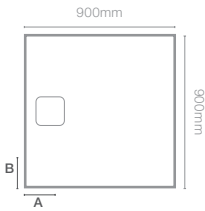

Rectangle	Size	A	B
	1000 x 800	121.5	500
	1000 x 900	121.5	500
	1100 x 800	121.5	550
	1100 x 900	121.5	550
	1200 x 700	121.5	550
	1200 x 760	121.5	600
	1200 x 800	121.5	600
	1200 x 900	121.5	600
	1300 x 800	121.5	650
	1300 x 900	121.5	650
	1400 x 760	121.5	700
	1400 x 800	121.5	700
	1400 x 900	121.5	700
	1500 x 800	121.5	750
	1500 x 900	121.5	750
	1600 x 800	121.5	800
	1600 x 900	121.5	800
	1700 x 760	121.5	850
	1700 x 800	121.5	850
	1700 x 900	121.5	850

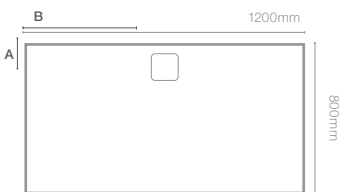

Quad	Size	A	B
	900 x 900	121.5	450

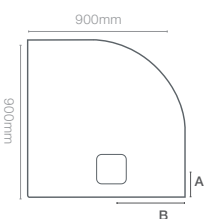

Offset Quad	Size	A	B
	1200 x 900	121.5	600

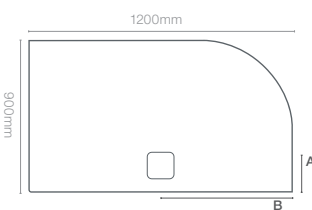

## Upstand Trays

Shape	Size	Waste Position A, mm	Waste Position B, mm
<b>Square</b>		<b>A</b>	<b>B</b>
	760	148	148
	800	148	148
	900	148	148

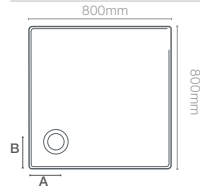

Rectangle	Size	A	B
	900 x 760	148	148
	1000 x 800	148	148
	1200 x 760	148	148
	1200 x 800	148	148
	1200 x 900	148	148
	1300 x 800	148	148
	1400 x 800	148	148
	1500 x 800	148	148

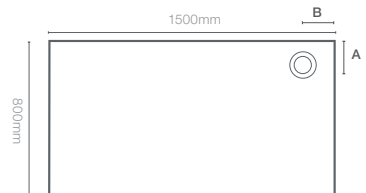

Rectangle & Square (centre waste)	Size	A	B
	900 x 900	148	450
	1000 x 800	148	500
	1200 x 800	148	600
	1700 x 800	148	148

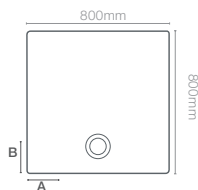
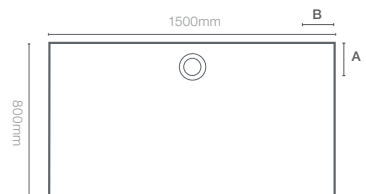



# Tray Waste Positions

## Touchstone Trays

Shape	Size	Waste Position A, mm	Waste Position B, mm
<b>Square</b>		<b>A</b>	<b>B</b>
	760	148	148
	800	148	148
	900	148	148

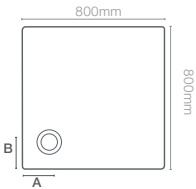

Rectangle	A	B
	800 x 700	148 148
	800 x 760	148 148
	900 x 700	148 148
	900 x 760	148 148
	900 x 800	148 148
	1000 x 700	148 148
	1000 x 760	148 148
	1000 x 800	148 148
	1000 x 900	148 148
	1100 x 760	148 148
	1100 x 800	148 148
	1100 x 900	148 148
	1200 x 700	148 148
	1200 x 760	148 148
	1200 x 800	148 148
	1200 x 900	148 148
	1300 x 800	148 148
	1300 x 900	148 148
	1400 x 700	148 148
	1400 x 760	148 148
	1400 x 800	148 148
	1400 x 900	148 148
	1500 x 700	148 148
	1500 x 760	148 148
	1500 x 800	148 148
	1500 x 900	148 148
	1600 x 700	148 148
	1600 x 760	148 148
	1600 x 800	148 148
	1600 x 900	148 148
	1685 x 700	148 148
	1680 x 760	148 148
	1600 x 900	148 148
	1685 x 700	148 148
	1700 x 800	130 850
	1700 x 900	130 850
	1800 x 760	130 900
	1800 x 800	130 900
	1800 x 900	130 900

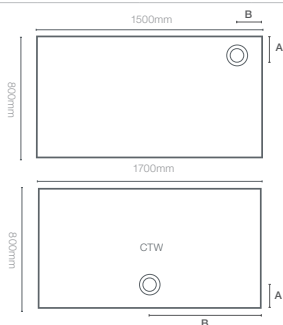

Waste is centred for 1700 x 800 / 1700 x 900 / 1800 x 700 / 1800 x 800 & 1800 x 900 trays

## Touchstone Trays - Continued

Shape	Size	Waste Position A, mm	Waste Position B, mm
<b>Quad</b>		<b>A</b>	<b>B</b>
	800	250	130
	900	350	130

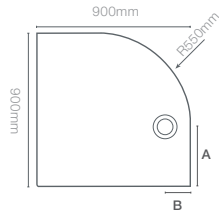

Offset Quad	A	B
	1000 x 800	350 130
	1200 x 800	450 130
	1200 x 900	450 130

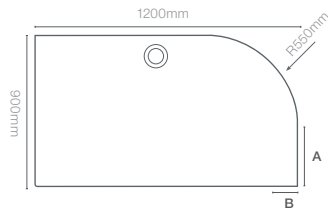

Left Handed (L) Right Handed (R)



Product is handed. Please choose L for Left or R for Right when ordering

## MStone Trays - Continued

Shape	Size	Waste Position A, mm	Waste Position B, mm
<b>Quad</b>		<b>A</b>	<b>B</b>
	800	250	130
	900	350	130
	1000	350	130

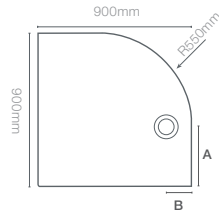

Offset Quad	A	B
	900 X 760	250 130
	1000 X 800	350 130
	1200 X 800	450 130
	1200 X 900	450 130

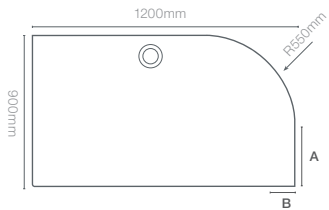

Left Handed (L) Right Handed (R)



Product is handed. Please choose L for Left or R for Right when ordering

## MStone Trays

Shape	Size	Waste Position A, mm	Waste Position B, mm
<b>Square</b>		<b>A</b>	<b>B</b>
	760	148	148
	800	148	148
	900	148	148

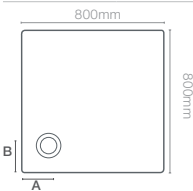

Rectangle	A	B
	900 x 760	148 148
	1000 x 800	148 148
	1100 x 760	148 148
	1100 x 800	148 148
	1200 x 700	148 148
	1200 x 760	148 148
	1200 x 800	148 148
	1200 x 900	148 148
	1400 x 800	148 148
	1400 x 900	148 148
	1500 x 700	148 148
	1500 x 800	148 148
	1500 x 900	148 148
	1600 x 800	148 148
	1600 x 900	148 148
	1685 x 700	148 148
	1680 x 760	148 148
	1700 x 800	850 130

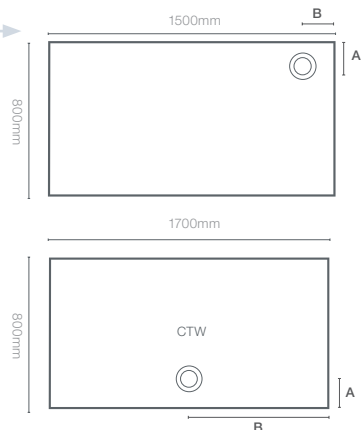

Waste is centred for 1700 x 800, 1700 x 900 and 1800 x 800 trays

# Mershield Stayclear



MERSHIELD™  
STAYCLEAR

*Without Mershield Stayclear™*

*With Mershield Stayclear™*

NATURAL GLASS SURFACE

GLASS SURFACE WITH MERSHIELD STAYCLEAR™ COATING

Mershield Stayclear™ creates a smooth layer over the surface of natural glass, lowering surface friction, making it easier for water, soap and lime deposits to run off the glass.

MERLYN treats every product in the Series Collection with a special protective coating to ensure the glass maintains its sparkle. This comes as standard as part of our on-going commitment to service.

Mershield Stayclear™ acts as a protective coating which when applied to glass, helps the glass to remain shiny and new without the need for tiresome cleaning.

When cleaned correctly it helps prevent the build up of lime-scale and soap deposits making the shower glass "easy to clean". Please see tips for keeping the glass in pristine condition on page 150.



LIFETIME  
GUARANTEE

## MERLYN Lifetime Guarantee

MERLYN is committed to developing products that meet the highest demands in terms of design, performance and quality. Due to our extreme confidence in our products and our unrelenting desire to deliver only the highest level of service, we have created the MERLYN Lifetime Guarantee.

MERLYN shower enclosures are crafted and engineered for a lifetime.

For more about our MERLYN Lifetime Guarantee, contact our MERLYN customer service team on **0808 1011 429**

REGISTER your new MERLYN product for the Lifetime Guarantee - log on to **www.merlynshowering.com** and fill in your information.

# UKCA, CE & EN Information

The UKCA (UK Conformity Assessment) mark on MERLYN enclosures is the new standard marking for products on the market in Great Britain (England, Wales and Scotland). It is a declaration that the product complies with GB designated standards.

The CE markings on MERLYN enclosures is a declaration that the product complies with the essential requirements of the relevant European health, safety and environmental protection legislation.

EU and GB legislation requires manufacturers to display either the UKCA mark for Great Britain and a CE mark for the EU and Northern Ireland on their product or packaging. It is an offence to place a product on the relevant market without a UKCA for Great Britain or CE marking for the EU market.

The manufacturer is legally responsible for ensuring that the product conforms to the requirements of both directives.

The European Commission thus refers to the CE marking as a "Passport" which allows products to be freely circulated within the EU single market. The UKCA marking allows products to move freely within Great Britain.

Often consumers will consider the UKCA and CE markings on a product as an indication of conformance to laid down minimum standards and therefore, a minimum level of safety which other products may lack. Both markings are often seen by consumers as a "Symbol of Safety."



<b>UKCA</b>	
<b>CE</b>	
UK Distributor: Merlyn (a division of NG4L), Ladysfield House, Station Rd, Wilmsham, Chester, SK9 1BU.	Manufacturer: Merlyn Industries Limited, Unit 8, Parnockinch Ind. Estate, Kilkenny, Ireland, R95 HPY 1.
19	
UKCA DOP: UKCATZ1.1 CE DOP: CETZ1.1	
Product Code here (MER13)	
PH	
<b>EN 14428</b>	
CAIRIDA	

<b>M</b> 1series	
1 DOOR QUADRANT SHOWER ENCLOSURE	
HEIGHT	1850
SIZE ADJUSTMENT	900 875-900
COLOR	CHROME
GLASS	CLEAR
CODE	V04HC00
WEIGHT	47KG
PD	70004
0035-0402	



MERLYN invests heavily in its product development and as such guarantees that its glass fully complies with regulations and is manufactured in accordance with BS EN 14428. The rigorous testing of the glass ensures that the endurance, stability and water retention criteria meet high industry standards.

**New GB, EU and NI label**

# ISO Certification

MERLYN has implemented an Integrated Management System comprising of Quality Management, Environmental Management and Occupational Health and Safety Management. An Integrated Management System ensures the seamless integration of several different standards into a common system that meets the requirements of each of these standards. These certifications are proof of MERLYN's credibility but also to instil confidence in our potential consumers that MERLYN will keep its promises.







# MERLYN™

Unit 8, Purcellsinch Industrial Estate, Dublin Road,  
Kilkenny, Ireland, R95 HP71.

T UK: 0808 1011 429 / IRL: 056 7791 576  
or E: sales@merlyn.ie / technical@merlyn.ie

[www.merlynshowering.com](http://www.merlynshowering.com)



## MERLYN™ THE COLLECTION

